

CONDIÇÕES GERAIS DE VENDA

Todos os pedidos implicam a aceitação sem reserva, das condições que se estipulam em seguida:

1. Recomenda-se que os pedidos sejam feitos através das folhas de pedido presentes neste catálogo.

2. A mercadoria viaja sempre por conta e risco do cliente.

3. No Continente os custos de transporte das mercadorias são de nossa conta, exopto no caso de encomendas com valores inferiores a 175 €

a) No caso de mercadoria com medida superior a 4,00 mts (considerado transporte especial) o custo adicional do transporte é suportado pelo cliente.

4. Nos Açores e Madeira, aplica-se o mesmo da alinea anterior, mas só até ao transitário.

5. Ao receber a mercadoria, deverá confirmar o nome de destinatário e o número de volumes que consta na guia. Também por sequente, deverá verificar o bom estado da mesma, constatando que estará isenta de golpes ou deformações no que toca à embalagem.

Caso detecte alguma destas ou outras anormalias, deverá, antes de assinar, mencioná-lo na guia e participa-lo no prazo máximo de 24 horas à Giferant.

O não cumprimento deste processo, ilibará a Giferant de qualquer responsabilidade no caso de mercadoria danificada.

6. Só serão aceites devoluções em caso de defeito de fabrico.

a) Nunca serão aceites devoluções de material encomendado especialmente para o cliente.

7. As encomendas só serão satisfeitas se as faturas estiverem liquidadas.

8. Sobre os preços da presente tabela será aplicado o I.V.A em vigor.

9. Em caso de litígio o foro competente é o da Comarca de Alcobaça.

10. A  reserva o direito de modificar as suas coleções assim como o preço de venda sem aviso prévio.

SISTEMA DE ROLO

COLEÇÃO CHIC	PÁG. 4
COLEÇÃO IRÍS	PÁG. 5
COLEÇÃO IRÍS BLACKOUT	PÁG. 6
COLEÇÃO ALCOA	PÁG. 7
COLEÇÃO SCREEN BLACOUT	PÁG. 8
COLEÇÃO SCREEN 1000	PÁG. 9
COLEÇÃO SCREEN 3500	PÁG. 10
COLEÇÃO SCREEN 4500	PÁG. 11
COLEÇÃO SCREEN 5500	PÁG. 12
COLEÇÃO JUTA	PÁG. 13
COLEÇÃO SCREEN DECOR	PÁG. 14
COLEÇÃO ESTEIRA	PÁG. 15
COLEÇÃO SCREEN TÊXTIL	PÁG. 16
COLEÇÃO SCREEN FANTASIA	PÁG. 17
COLEÇÃO SCREEN SOLAR	PÁG. 18
COLEÇÃO BLACKOUT SOLAR	PÁG. 19
COLEÇÃO SHANTUNG BLACKOUT	PÁG. 20
COLEÇÃO LINHO BLACKOUT	PÁG. 21
COLEÇÃO LINHO	PÁG. 22
COLEÇÃO MICRO SHANTUNG	PÁG. 23
COLEÇÃO SHANTUNG	PÁG. 24
COLEÇÃO NOITE / DIA	PÁG. 25
MOTORES E COMANDOS	PÁG. 26
CAIXAS E GUIAS	PÁG. 27
MANIVELA E CABO AÇO	PÁG. 28

SISTEMA MINIBOX

COLEÇÃO IRÍS	PÁG. 30
COLEÇÃO ALCOA	PÁG. 31
COLEÇÃO SCREEN 3500	PÁG. 32

SISTEMA DE ROLO MOSQUITEIRA

MOSQUITEIRA	PÁG. 34
-------------	---------

SISTEMA DE BANDAS VERTICAIS

COLEÇÃO IRÍS	PÁG. 36
COLEÇÃO SHANTUNG	PÁG. 36
COLEÇÃO LINHO	PÁG. 36
COLEÇÃO ALCOA	PÁG. 37
COLEÇÃO IRIS BLACOT	PÁG. 37
COLEÇÃO SHANTUNG BLACKOUT	PÁG. 37
COLEÇÃO ESTEIRA	PÁG. 38
COLEÇÃO SCREEN 3500	PÁG. 38
COLEÇÃO LINHO BLACKOUT	PÁG. 38
COLEÇÃO SCREEN TEXTIL	PÁG. 39
COLEÇÃO SCREEN SOLAR	PÁG. 40
COLEÇÃO BLACKOUT SOLAR	PÁG. 40
COLEÇÃO SCREEN BLACKOUT	PÁG. 40
COLEÇÃO SCREEN 1000	PÁG. 41
COLEÇÃO JUTA	PÁG. 42
COLEÇÃO SCREEN DECOR	PÁG. 42
COLEÇÃO SCREEN 4500	PÁG. 43
COLEÇÃO SCREEN 5500	PÁG. 43
COLEÇÃO SCREEN FANTASIA	PÁG. 44

SISTEMA DE PAINEL DESLIZANTE

COLEÇÃO CHIC - IRIS	PÁG. 46
COLEÇÃO IRIS BLACKOUT - ALCOA	PÁG. 46
COLEÇÃO SCREEN BLACKOUT - SCREEN 1000	PÁG. 47
COLEÇÃO SCREEN 3500 - SCREEN 4500	PÁG. 47
COLEÇÃO SCREEN 5500 - JUTA	PÁG. 48
COLEÇÃO SCREEN DECOR - ESTEIRA	PÁG. 48
COLEÇÃO LINHO BLACKOUT- BLACKOUT SOLAR	PÁG. 49
COLEÇÃO SCREEN SOLAR - LINHO BLACKOUT	PÁG. 49
COLEÇÃO LINHO - MICRO SHANTUNG	PÁG. 50
COLEÇÃO SHANTUNG - SCREEN TÊXTIL	PÁG. 50

SISTEMA VENEZIANO DE MADEIRA

VENEZIANO DE MADEIRA 50MM	PÁG. 52
---------------------------	---------

FOLHAS DE PEDIDOS

FOLHA ESTOR DE ROLO	PÁG. 54
FOLHA PAINEL DESLIZANTE	PÁG. 55
FOLHA BANDAS VERTICAIS	PÁG. 56

SISTEMA DE ROLO

SISTEMA ROLO

Características técnicas

COLEÇÃO CHIC

TABELA PREÇOS P.V.P €
iva não incluído



ALTURA	DIAM 40							DIAM 45					
	0,8	1,0	1,2	1,4	1,6	1,8	2,0	2,2	2,4	2,6	2,8	3,0	3,2
1,0	42,56	49,74	55,00	61,24	67,40	73,22	79,88	86,34	92,86	98,30	104,66	110,60	118,92
1,2	44,94	51,50	58,88	64,64	71,32	78,56	84,44	91,60	98,90	104,74	111,70	118,32	126,08
1,4	47,90	54,14	61,64	68,76	75,38	82,78	89,72	96,58	103,74	110,02	118,32	125,48	134,88
1,6	49,44	56,66	64,32	71,22	79,80	87,04	94,66	102,36	109,66	117,94	124,70	132,44	141,92
1,8	51,88	59,88	67,56	75,04	83,54	91,80	99,54	107,38	115,34	123,44	131,02	139,90	149,04
2,0	53,22	61,30	70,40	78,78	87,10	95,42	104,68	113,02	121,22	130,36	138,56	147,32	157,32
2,2	55,00	64,74	73,38	82,66	91,62	100,48	109,20	118,56	127,56	136,04	145,12	154,24	165,64
2,4	57,74	67,12	76,42	85,32	95,90	104,32	114,98	123,90	133,96	142,00	152,20	161,88	172,98
2,6	59,70	69,08	79,88	89,90	99,78	109,26	119,24	129,10	138,34	148,66	158,04	168,72	180,34
2,8	61,34	72,44	82,34	92,12	103,44	113,12	124,22	134,66	144,08	155,18	165,88	176,06	188,70
3,0	63,50	74,62	85,22	96,66	107,08	118,98	129,34	139,62	150,30	161,38	172,40	183,74	195,78
3,2	66,38	77,02	88,08	100,74	111,80	122,06	133,90	145,74	156,90	167,10	179,64	190,50	203,44

NOTA: A tela Chic com largura acima de 2,10 metros terá que levar emenda.

Os estores são manuais com acionamento lateral de corrente branca e contra-peso interior (oculto). Nos preços com fundo de cor, aconselhamos sistema desmultiplicador, que por sua vez tem um valor acrescido, sendo esta uma opção do cliente.



CONTRA-PESO DECORATIVO



CONTRA-PESO INTERIOR (STANDART)



ENROLAMENTO EXTERIOR (STANDART)



ENROLAMENTO INTERIOR

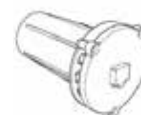

SISTEMA DESMULTIPLICADOR
VALOR ACRESCIDO 56,65 €

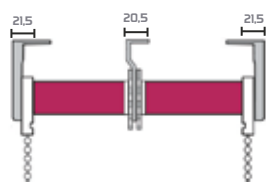

ESTOR DUPLO (PREÇO IGUAL AO DE DOIS ESTORES)

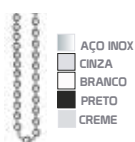

CORRENTE (COR STANDART: BRANCO)



CONTRA PESO CORRENTE
VALOR ACRESCIDO 1,48 €



TAMPAS E SUPORTES (COR STANDART: BRANCO)

DISPOSITIVOS SEGURANÇA INFANTIL



VALOR ACRESCIDO 0,66 €



VALOR ACRESCIDO 0,88 €



NORMA EN 13120
SEGURANÇA CONTRA RISCOS DE ESTRANGULAMENTO
MAIS INFORMAÇÕES NO NOSSO CATÁLOGO GERAL

SISTEMA ROLO

Características técnicas

COLEÇÃO ÍRIS

TABELA PREÇOS P.V.P €
iva não incluído



ALTURA	LARGURA												
	DIAM 40						DIAM 45						
	0,8	1,0	1,2	1,4	1,6	1,8	2,0	2,2	2,4	2,6	2,8	3,0	3,2
1,0	37,44	42,78	48,18	53,82	59,00	63,86	69,74	75,10	81,24	85,52	91,32	96,04	103,68
1,2	40,04	44,52	51,80	56,62	62,48	68,48	74,02	79,82	85,96	91,46	97,08	103,08	110,98
1,4	40,58	47,14	53,26	59,62	65,82	72,02	78,50	84,58	90,64	97,72	103,10	109,86	117,30
1,6	42,70	50,02	56,06	62,74	69,18	75,54	82,76	89,56	95,92	102,38	108,68	115,64	124,52
1,8	45,14	52,42	59,70	65,86	72,72	79,92	87,20	94,02	100,84	107,18	115,32	122,00	130,40
2,0	47,20	53,74	61,46	68,42	76,58	83,50	91,22	98,76	105,16	113,86	121,32	128,86	137,38
2,2	48,62	56,44	63,96	71,34	79,52	87,58	94,98	103,32	110,28	118,80	127,66	133,96	144,10
2,4	50,36	58,68	66,38	74,34	83,76	91,56	99,36	108,08	116,74	123,62	132,90	140,08	150,84
2,6	51,72	60,88	69,54	77,80	86,64	95,58	104,04	112,76	121,80	130,62	138,06	148,74	157,90
2,8	54,98	62,82	71,16	80,42	90,94	99,42	108,38	117,30	126,22	135,06	144,34	154,98	164,52
3,0	56,76	65,74	74,46	83,50	93,78	103,06	113,56	122,66	131,76	140,00	150,50	160,24	171,08
3,2	58,26	67,00	77,28	87,68	97,40	107,80	116,40	126,78	136,68	147,82	156,90	166,74	177,60

NOTA: A tela Íris com largura acima de 3,00 metros terá que levar emenda.

Os estores são manuais com acionamento lateral de corrente branca e contra-peso interior (oculto). Nos preços com fundo de cor, aconselhamos sistema desmultiplicador, que por sua vez tem um valor acrescido, sendo esta uma opção do cliente.



CONTRA-PESO
DECORATIVO



CONTRA-PESO
INTERIOR
(STANDART)



ENROLAMENTO
EXTERIOR
(STANDART)



ENROLAMENTO
INTERIOR



SISTEMA DESMULTPLICADOR
VALOR ACRESCIDO 56,65€

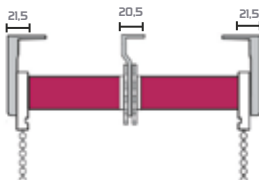

ESTOR DUPLO
(PREÇO IGUAL AO DE DOIS
ESTORES)



CORRENTE
(COR STANDART: BRANCO)



CONTRA PESO
CORRENTE
VALOR ACRESCIDO 1,48 €



TAMPAS E SUPORTES
(COR STANDART: BRANCO)

DISPOSITIVOS SEGURANÇA INFANTIL



VALOR ACRESCIDO 0,66 €



VALOR ACRESCIDO 0,88 €

TENSORES DE CORRENTE



NORMA EN 13120
SEGURANÇA CONTRA RISCOS DE
ESTRANGULAMENTO
MAIS INFORMAÇÕES
NO NOSSO CATÁLOGO GERAL

SISTEMA ROLO

Características técnicas

COLEÇÃO ÍRIS BLACKOUT

TABELA PREÇOS P.V.P €
iva não incluído



ALTURA	LARGURA												
	DIAM 40					DIAM 45							
	0,8	1,0	1,2	1,4	1,6	1,8	2,0	2,2	2,4	2,6	2,8	3,0	3,2
1,0	51,72	59,74	67,90	74,28	82,22	90,76	98,44	105,88	113,30	120,46	129,30	136,26	146,20
1,2	54,90	63,66	71,24	80,04	88,44	96,18	104,74	113,80	120,72	130,82	138,26	146,08	156,62
1,4	57,86	66,40	75,94	84,66	93,70	102,94	111,34	119,84	129,92	138,26	147,44	156,58	167,44
1,6	60,42	69,74	79,98	88,62	98,76	108,02	118,66	126,22	137,32	147,80	156,64	166,36	177,74
1,8	62,08	73,12	83,42	93,84	104,52	114,86	125,46	134,86	144,94	154,74	164,94	175,80	188,70
2,0	65,92	77,90	88,78	98,90	109,20	119,86	130,08	142,32	153,88	164,48	174,60	186,66	198,96
2,2	68,28	80,96	91,20	103,74	115,74	125,02	137,40	150,64	160,10	172,00	184,90	195,32	209,34
2,4	71,08	83,06	96,96	108,28	119,78	132,76	144,52	157,50	169,34	180,54	192,84	205,46	219,46
2,6	75,90	87,78	100,24	113,76	124,18	138,90	150,06	164,32	176,28	190,80	202,18	214,24	229,24
2,8	77,24	90,22	104,08	117,28	131,76	144,08	158,44	171,38	184,70	198,62	212,88	224,60	240,04
3,0	79,44	94,86	109,90	122,88	136,80	150,52	163,80	178,06	192,60	206,38	220,44	234,66	250,18
3,2	82,52	96,94	112,54	127,34	142,98	155,60	171,06	186,74	200,74	214,56	230,98	245,90	260,60

NOTA: A tela Íris Blackout com largura acima de 3,00 metros terá que levar emenda.

Os estores são manuais com acionamento lateral de corrente branca e contra-peso interior (oculto). Nos preços com fundo de cor, aconselhamos sistema desmultiplicador, que por sua vez tem um valor acrescido, sendo esta uma opção do cliente.



CONTRA-PESO DECORATIVO



CONTRA-PESO INTERIOR (STANDART)



ENROLAMENTO EXTERIOR (STANDART)



ENROLAMENTO INTERIOR

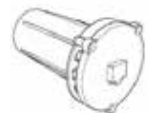

SISTEMA DESMULTIPLICADOR

VALOR ACRESCIDO 56,65 €

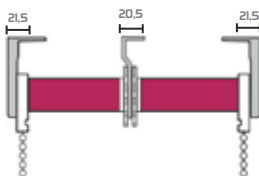

ESTOR DUPLO (PREÇO IGUAL AO DE DOIS ESTORES)



CORRENTE (COR STANDART: BRANCO)



CONTRA PESO CORRENTE VALOR ACRESCIDO 1,48 €



TAMPAS E SUPORTES (COR STANDART: BRANCO)

DISPOSITIVOS SEGURANÇA INFANTIL



VALOR ACRESCIDO 0,66 €



VALOR ACRESCIDO 0,88 €



NORMA EN 13120

SEGURANÇA CONTRA RISCOS DE ESTRANGULAMENTO
MAIS INFORMAÇÕES NO NOSSO CATÁLOGO GERAL

TENSORES DE CORRENTE

SISTEMA ROLO
Características técnicas

COLEÇÃO ALCOA

TABELA PREÇOS P.V.P €
iva não incluído

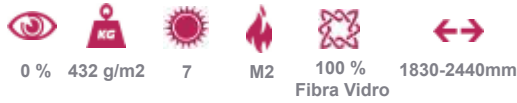

ALTURA	DIAM 40							DIAM 45						
	0,8	1,0	1,2	1,4	1,6	1,8	2,0	2,2	2,4	2,6	2,8	3,0	3,2	
1,0	51,74	61,82	69,22	77,42	86,78	94,82	102,98	110,86	120,54	128,66	136,90	145,82	154,68	
1,2	56,82	65,88	74,94	83,52	92,66	100,90	110,44	120,88	129,74	138,94	147,66	157,84	167,98	
1,4	58,28	69,62	79,18	88,20	99,22	109,60	119,78	129,80	139,12	149,30	159,72	169,70	180,66	
1,6	63,56	73,90	83,26	95,76	105,24	116,14	127,66	138,00	148,64	158,74	170,78	181,90	193,92	
1,8	66,62	77,22	89,62	101,98	113,74	124,56	135,90	146,70	157,82	170,18	181,44	192,36	206,84	
2,0	69,96	81,84	94,64	106,78	118,12	131,98	143,00	155,44	168,32	180,26	192,88	205,22	219,74	
2,2	73,62	86,88	99,76	112,66	125,32	138,22	151,62	165,34	177,66	190,94	204,20	216,70	231,74	
2,4	77,98	91,36	104,62	118,34	132,76	146,78	160,98	173,88	187,30	201,44	216,92	229,86	244,16	
2,6	80,84	95,80	109,38	123,72	138,44	154,86	168,70	182,64	197,88	211,82	226,10	241,44	258,52	
2,8	83,06	99,22	115,76	130,88	145,30	160,92	176,44	192,58	207,40	222,40	238,74	253,26	270,96	
3,0	87,84	103,88	119,94	136,90	152,90	168,88	185,66	200,44	217,96	232,98	249,38	265,48	283,84	
3,2	91,68	108,90	125,48	141,10	159,88	175,62	193,38	209,88	226,70	243,62	260,10	277,26	296,58	

NOTA: A tela Alcoa com largura acima de 1,83 metros terá que levar emenda.

Os estores são manuais com acionamento lateral de corrente branca e contra-peso interior (oculto). Nos preços com fundo de cor, aconselhamos sistema desmultiplicador, que por sua vez tem um valor acrescido, sendo esta uma opção do cliente.



CONTRA-PESO
DECORATIVO



CONTRA-PESO
INTERIOR
(STANDART)



ENROLAMENTO
EXTERIOR
(STANDART)



ENROLAMENTO
INTERIOR

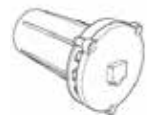

SISTEMA DESMULTIPLICADOR
VALOR ACRESCIDO 56,65 €

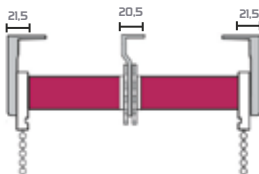

ESTOR DUPLO
(PREÇO IGUAL AO DE DOIS
ESTORES)



CORRENTE
(COR STANDART: BRANCO)



CONTRA PESO
CORRENTE
VALOR ACRESCIDO 1,48 €



TAMPAS E SUPORTES
(COR STANDART: BRANCO)



VALOR ACRESCIDO 0,66 €



VALOR ACRESCIDO 0,88 €

TENSORES DE CORRENTE



NORMA EN 13120
SEGURANÇA CONTRA RISCOS DE
ESTRANGULAMENTO
MAIS INFORMAÇÕES
NO NOSSO CATALÓGO GERAL

DISPOSITIVOS SEGURANÇA INFANTIL

SISTEMA ROLO
Características técnicas

COLEÇÃO SCREEN BLACKOUT

TABELA PREÇOS P.V.P €
iva não incluído



ALTURA	LARGURA								LARGURA				
	DIAM 40								DIAM 45				
	0,8	1,0	1,2	1,4	1,6	1,8	2,0	2,2	2,4	2,6	2,8	3,0	3,2
1,0	107,56	128,74	148,00	169,24	189,90	210,22	231,88	251,34	273,86	293,30	314,66	335,60	357,22
1,2	117,24	141,50	164,88	188,64	210,32	234,56	256,44	279,00	303,90	326,74	349,70	372,32	396,08
1,4	129,90	154,56	180,94	205,06	231,38	257,78	282,92	307,58	333,74	358,42	384,32	409,48	437,32
1,6	140,44	168,66	196,32	223,82	252,80	279,04	307,66	335,36	363,66	392,94	419,70	447,44	477,76
1,8	151,88	182,88	211,56	242,04	272,54	302,80	333,54	362,38	393,34	423,44	454,02	485,90	516,04
2,0	161,12	194,30	227,40	260,78	292,10	325,42	359,68	390,02	423,22	456,36	489,86	522,52	556,52
2,2	172,00	207,74	243,38	278,66	313,62	348,68	383,20	418,56	453,56	489,04	524,32	559,54	597,64
2,4	184,74	220,62	258,72	295,32	334,90	371,32	409,98	446,90	485,96	521,10	559,20	597,88	636,98
2,6	194,70	233,98	274,88	315,90	355,78	394,26	433,24	473,90	514,34	554,66	594,04	635,72	676,34
2,8	205,34	247,74	289,74	331,72	375,44	417,22	459,22	502,66	543,08	586,18	630,88	671,66	716,70
3,0	215,50	261,62	305,22	350,66	395,08	440,98	485,34	530,62	575,30	619,38	664,40	709,74	756,78
3,2	226,98	274,02	321,48	369,74	415,10	462,06	510,90	557,94	604,60	652,10	700,64	746,70	795,64

NOTA: A tela Screen Blackout com largura acima de 2,40 metros terá que levar emenda.
Os estores são manuais com acionamento lateral de corrente branca e contra-peso interior (oculto). Nos preços com fundo de cor, aconselhamos sistema desmutiplicador, que por sua vez tem um valor acrescido, sendo esta uma opção do cliente.



CONTRA-PESO DECORATIVO



CONTRA-PESO INTERIOR (STANDART)



ENROLAMENTO EXTERIOR (STANDART)



ENROLAMENTO INTERIOR

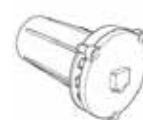

SISTEMA DESMULTIPLICADOR
VALOR ACRESCIDO 56,65 €

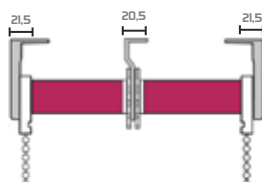

ESTOR DUPLO (PREÇO IGUAL AO DE DOIS ESTORES)



CORRENTE (COR STANDART: BRANCO)



CONTRA PESO CORRENTE
VALOR ACRESCIDO 1,48 €

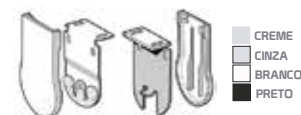

TAMPAS E SUPORTES (COR STANDART: BRANCO)

DISPOSITIVOS SEGURANÇA INFANTIL



VALOR ACRESCIDO 0,66 €



VALOR ACRESCIDO 0,88€



NORMA EN 13120
SEGURANÇA CONTRA RISCOS DE ESTRANGULAMENTO
MAIS INFORMAÇÕES NO NOSSO CATÁLOGO GERAL

SISTEMA ROLO

Características técnicas

COLEÇÃO SCREEN 1000

TABELA PREÇOS P.V.P €
iva não incluído



ALTURA	LARGURA								LARGURA				
	DIAM 40								DIAM 45				
	0,8	1,0	1,2	1,4	1,6	1,8	2,0	2,2	2,4	2,6	2,8	3,0	3,2
1,0	72,82	84,06	98,22	110,48	123,82	136,56	148,30	162,64	174,72	188,86	200,66	213,32	227,84
1,2	78,30	92,60	106,08	120,96	135,48	148,88	163,66	178,90	191,82	206,02	220,90	234,68	250,76
1,4	84,14	100,32	116,74	131,22	146,22	162,32	177,34	192,22	209,96	224,74	240,34	255,42	273,90
1,6	91,98	107,04	123,22	142,88	158,94	175,28	191,30	209,06	226,44	242,24	260,98	276,90	295,74
1,8	97,44	115,78	132,02	151,30	170,08	187,04	206,42	225,58	243,28	261,88	279,34	297,32	317,16
2,0	103,08	122,32	142,44	161,70	181,54	198,80	220,54	240,30	259,96	279,66	298,76	318,48	340,82
2,2	108,36	130,28	151,68	172,44	193,90	214,12	235,60	255,82	277,40	298,74	319,04	340,44	363,88
2,4	115,88	137,88	159,72	183,70	204,14	227,66	250,92	272,88	294,70	316,14	339,86	362,94	385,74
2,6	120,30	145,04	168,02	193,48	216,50	240,48	263,06	287,66	311,38	335,78	359,72	382,00	408,32
2,8	127,98	152,26	177,40	202,96	227,64	253,74	278,22	303,66	328,04	353,42	378,22	403,82	431,54
3,0	132,80	160,74	187,98	213,48	239,74	266,78	293,96	318,08	345,26	371,80	398,78	425,88	453,68
3,2	139,54	166,06	195,42	224,82	251,42	279,26	307,08	334,70	363,88	390,46	418,44	446,46	476,56

NOTA: A tela Screen 1000 com largura acima de 3,00 metros terá que levar emenda.

Os estores são manuais com acionamento lateral de corrente branca e contra-peso interior (oculto). Nos preços com fundo de cor, aconselhamos sistema desmultiplicador, que por sua vez tem um valor acrescido, sendo esta uma opção do cliente.



CONTRA-PESO DECORATIVO



CONTRA-PESO INTERIOR (STANDART)



ENROLAMENTO EXTERIOR (STANDART)



ENROLAMENTO INTERIOR

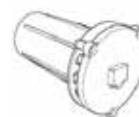

SISTEMA DESMULTIPLICADOR
VALOR ACRESCIDO 56,65 €

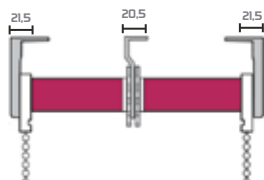

ESTOR DUPLO (PREÇO IGUAL AO DE DOIS ESTORES)



CORRENTE (COR STANDART: BRANCO)



CONTRA PESO CORRENTE
VALOR ACRESCIDO 1,48 €



TAMPAS E SUPORTES (COR STANDART: BRANCO)



VALOR ACRESCIDO 0,66 €



VALOR ACRESCIDO 0,88 €

TENSORES DE CORRENTE

DISPOSITIVOS SEGURANÇA INFANTIL



NORMA EN 13120
SEGURANÇA CONTRA RISCOS DE ESTRANGULAMENTO
MAIS INFORMAÇÕES NO NOSSO CATALÓGO GERAL

SISTEMA ROLO

Características técnicas

COLEÇÃO SCREEN 3500

TABELA PREÇOS P.V.P €
iva não incluído



ALTURA	LARGURA								LARGURA				
	DIAM 40								DIAM 45				
	0,8	1,0	1,2	1,4	1,6	1,8	2,0	2,2	2,4	2,6	2,8	3,0	3,2
1,0	54,56	63,74	71,00	80,24	88,40	98,22	106,88	115,34	124,86	133,30	141,66	150,60	160,92
1,2	57,94	67,50	77,88	87,64	96,32	105,56	115,44	124,60	134,90	144,74	154,70	164,32	175,08
1,4	61,90	71,14	83,64	92,76	103,38	114,78	124,72	134,58	145,74	155,02	166,32	176,48	188,88
1,6	65,44	76,66	87,32	99,22	111,80	121,04	133,66	144,36	156,66	167,94	178,70	189,44	202,86
1,8	69,88	81,88	93,56	105,04	117,54	129,80	141,54	153,38	166,34	177,44	189,02	202,90	216,04
2,0	72,22	85,30	98,40	112,78	123,10	137,42	151,68	162,02	176,22	188,36	202,56	215,32	230,32
2,2	76,00	90,74	104,38	118,66	131,62	145,48	158,20	172,56	187,56	199,04	214,12	227,24	243,64
2,4	80,74	94,12	109,42	123,32	138,90	152,32	168,98	183,90	197,96	211,00	225,20	241,88	257,98
2,6	84,70	98,08	115,88	130,90	146,78	160,26	176,24	191,10	207,34	223,66	237,04	254,72	271,34
2,8	87,34	104,44	119,34	136,12	152,44	169,12	185,22	201,66	217,08	233,18	251,88	266,06	285,70
3,0	91,50	108,62	125,22	142,66	159,08	177,98	193,34	211,62	227,30	245,38	262,40	279,74	298,78
3,2	95,38	112,02	130,08	149,74	166,80	184,06	202,90	221,74	237,90	256,10	274,64	292,50	312,44

NOTA: A tela Screen 3500 com largura acima de 3,00 metros terá que levar emenda. Os estores são manuais com acionamento lateral de corrente branca e contra-peso interior (oculto). Nos preços com fundo de cor, aconselhamos sistema desmultiplicador, que por sua vez tem um valor acrescido, sendo esta uma opção do cliente.



CONTRA-PESO DECORATIVO



CONTRA-PESO INTERIOR (STANDART)



ENROLAMENTO EXTERIOR (STANDART)



ENROLAMENTO INTERIOR

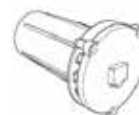

SISTEMA DESMULTIPLICADOR
VALOR ACRESCIDO 56,65 €

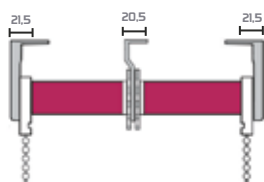

ESTOR DUPLO (PREÇO IGUAL AO DE DOIS ESTORES)

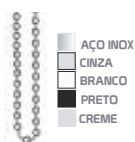

CORRENTE (COR STANDART: BRANCO)



CONTRA PESO CORRENTE
VALOR ACRESCIDO 1,48 €



TAMPAS E SUPORTES (COR STANDART: BRANCO)



VALOR ACRESCIDO 0,66 €



VALOR ACRESCIDO 0,88 €

TENSORES DE CORRENTE

DISPOSITIVOS SEGURANÇA INFANTIL



NORMA EN 13120
SEGURANÇA CONTRA RISCOS DE ESTRANGULAMENTO
MAIS INFORMAÇÕES NO NOSSO CATÁLOGO GERAL

SISTEMA ROLO

Características técnicas

COLEÇÃO SCREEN 4500

TABELA PREÇOS P.V.P €
iva não incluído



ALTURA	LARGURA								LARGURA				
	DIAM 40								DIAM 45				
	0,8	1,0	1,2	1,4	1,6	1,8	2,0	2,2	2,4	2,6	2,8	3,0	3,2
1,0	62,80	72,34	83,88	93,30	103,94	114,16	125,42	135,22	145,14	156,44	167,20	177,36	190,32
1,2	66,22	78,88	89,60	101,74	112,66	124,98	136,80	147,48	159,70	170,88	183,74	194,82	207,02
1,4	71,86	83,40	96,74	109,66	122,70	134,94	147,34	160,34	172,92	184,26	198,14	210,58	225,44
1,6	75,42	90,74	103,58	116,02	131,76	144,02	158,66	172,22	185,32	199,80	213,08	226,36	242,74
1,8	80,08	94,72	110,42	124,14	139,52	155,46	169,46	184,86	199,74	212,24	228,14	243,70	260,70
2,0	85,02	101,90	117,78	133,90	148,00	165,36	180,08	195,12	213,88	228,48	243,60	260,66	278,96
2,2	89,28	107,56	123,20	141,74	158,74	174,02	191,40	208,64	225,10	242,00	259,90	276,32	294,34
2,4	94,08	113,06	131,96	148,08	167,28	185,76	203,52	220,50	238,34	257,54	274,24	293,46	312,46
2,6	100,90	119,78	138,24	157,76	175,18	195,90	213,06	233,32	251,08	271,80	289,18	309,24	329,24
2,8	104,24	124,22	144,08	165,28	185,76	205,08	224,44	245,38	265,70	285,62	305,88	325,00	347,04
3,0	109,44	131,86	152,90	173,88	194,80	215,12	236,80	258,06	278,00	300,38	320,44	342,66	364,18
3,2	114,12	136,14	159,54	180,34	203,98	224,00	247,06	269,74	292,74	314,26	336,98	359,90	382,00

NOTA: A tela Screen 4500 com largura acima de 2,50 metros terá que levar emenda.

Os estores são manuais com acionamento lateral de corrente branca e contra-peso interior (oculto). Nos preços com fundo de cor, aconselhamos sistema desmutiplicador, que por sua vez tem um valor acrescido, sendo esta uma opção do cliente.



CONTRA-PESO
DECORATIVO



CONTRA-PESO
INTERIOR
(STANDART)



ENROLAMENTO
EXTERIOR
(STANDART)



ENROLAMENTO
INTERIOR

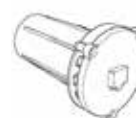

SISTEMA DESMULTIPLICADOR
VALOR ACRESCIDO 56,65 €

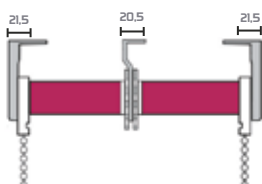

ESTOR DUPLO
(PREÇO IGUAL AO DE DOIS
ESTORES)

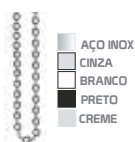

CORRENTE
(COR STANDART: BRANCO)



CONTRA PESO
CORRENTE
VALOR ACRESCIDO 1,48 €

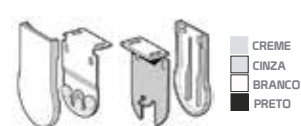

TAMPAS E SUPORTES
(COR STANDART: BRANCO)



VALOR ACRESCIDO 0,66 €



VALOR ACRESCIDO 0,88 €

TENSORES DE CORRENTE

DISPOSITIVOS SEGURANÇA INFANTIL



NORMA EN 13120
SEGURANÇA CONTRA RISCOS DE
ESTRANGULAMENTO
MAIS INFORMAÇÕES
NO NOSSO CATÁLOGO GERAL

SISTEMA ROLO
Características técnicas

COLEÇÃO SCREEN 5500

TABELA PREÇOS P.V.P €
iva não incluído



ALTURA	LARGURA								LARGURA				
	DIAM 40								DIAM 45				
	0,8	1,0	1,2	1,4	1,6	1,8	2,0	2,2	2,4	2,6	2,8	3,0	3,2
1,0	72,80	85,74	98,88	111,70	124,94	137,66	150,42	163,42	176,44	189,44	202,20	215,36	230,32
1,2	79,22	93,88	107,60	122,74	136,66	150,98	165,80	179,48	193,70	208,88	222,74	236,82	252,82
1,4	85,86	101,40	116,74	132,66	148,70	163,94	179,34	195,34	211,92	226,26	242,54	258,58	275,44
1,6	91,42	108,74	125,58	142,82	159,86	177,02	194,66	211,22	228,32	245,80	262,68	279,70	298,74
1,8	97,08	116,72	134,42	153,14	171,52	190,46	208,76	227,86	245,74	264,24	282,64	301,70	321,70
2,0	103,92	123,90	143,78	163,90	183,50	203,36	223,38	243,12	263,88	282,48	302,60	322,76	344,70
2,2	110,28	131,56	152,20	174,74	195,74	216,02	237,40	259,64	280,10	301,50	322,90	344,32	367,34
2,4	116,08	139,06	161,96	184,08	206,28	229,76	252,52	274,50	297,34	320,54	342,84	365,66	389,96
2,6	122,90	146,78	170,24	194,76	218,18	242,90	266,06	290,32	314,94	338,80	362,98	387,94	412,84
2,8	128,24	154,22	179,08	205,28	230,76	255,08	281,44	306,38	332,70	357,62	383,88	409,60	435,74
3,0	135,44	161,86	188,90	215,88	242,80	269,12	295,80	322,06	349,60	376,38	403,44	430,66	458,18
3,2	141,12	169,14	197,54	225,34	254,08	282,00	310,06	338,74	366,74	395,26	423,98	451,90	481,50

NOTA: A tela Screen 5500 com largura acima de 2,85 metros terá que levar emenda. Os estores são manuais com acionamento lateral de corrente branca e contra-peso interior (oculto). Nos preços com fundo de cor, aconselhamos sistema desmultiplicador, que por sua vez tem um valor acrescido, sendo esta uma opção do cliente.



CONTRA-PESO DECORATIVO



CONTRA-PESO INTERIOR (STANDART)



ENROLAMENTO EXTERIOR (STANDART)



ENROLAMENTO INTERIOR

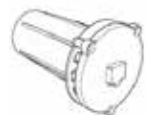

SISTEMA DESMULTPLICADOR
VALOR ACRESCIDO 56,65 €

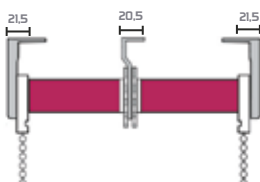

ESTOR DUPLO (PREÇO IGUAL AO DE DOIS ESTORES)

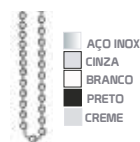

CORRENTE (COR STANDART: BRANCO)



CONTRA PESO CORRENTE
VALOR ACRESCIDO 1,48 €

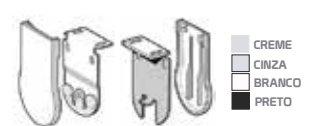

TAMPAS E SUPORTES (COR STANDART: BRANCO)



VALOR ACRESCIDO 0,66 €



VALOR ACRESCIDO 0,88 €

TENSORES DE CORRENTE

DISPOSITIVOS SEGURANÇA INFANTIL



NORMA EN 13120
SEGURANÇA CONTRA RISCOS DE ESTRANGULAMENTO
MAIS INFORMAÇÕES NO NOSSO CATÁLOGO GERAL

SISTEMA ROLO

Características técnicas

COLEÇÃO JUTA

TABELA PREÇOS P.V.P €
iva não incluído



ALTURA	LARGURA												
	DIAM 40							DIAM 45					
	0,8	1,0	1,2	1,4	1,6	1,8	2,0	2,2	2,4	2,6	2,8	3,0	3,2
1,0	95,80	113,34	130,88	148,30	166,94	185,16	202,42	220,22	238,14	256,44	274,20	291,36	311,32
1,2	104,22	124,88	144,60	164,74	184,66	203,98	223,80	243,48	263,70	283,88	303,74	323,82	345,02
1,4	113,86	135,40	157,74	179,66	201,70	223,94	245,34	267,34	289,92	311,26	333,14	355,58	379,44
1,6	122,42	146,74	170,58	195,02	218,76	243,02	266,66	290,22	314,32	338,80	363,08	387,36	412,74
1,8	131,08	157,72	184,42	210,14	236,52	262,46	288,46	314,86	340,74	366,24	392,14	418,70	446,70
2,0	141,02	169,90	197,78	225,90	254,00	281,36	310,08	338,12	366,88	394,48	422,60	450,66	480,96
2,2	150,28	180,56	210,20	240,74	270,74	301,02	331,40	361,64	391,10	422,00	451,90	482,32	514,34
2,4	159,08	191,06	223,96	256,08	288,28	320,76	352,52	384,50	417,34	449,54	481,24	513,46	547,46
2,6	168,90	202,78	237,24	271,76	305,18	339,90	374,06	408,32	442,08	476,80	511,18	545,24	581,24
2,8	177,24	214,22	250,08	286,28	323,76	359,08	395,44	431,38	468,70	504,62	540,88	577,00	615,04
3,0	187,44	225,86	263,90	302,88	340,80	378,12	417,80	455,06	493,00	532,38	570,44	608,66	649,18
3,2	196,12	236,14	277,54	317,34	357,98	398,00	438,06	479,74	519,74	559,26	600,98	640,90	683,00

NOTA: A tela Juta com largura acima de 2,50 metros terá que levar emenda.

Os estores são manuais com acionamento lateral de corrente branca e contra-peso interior (oculto). Nos preços com fundo de cor, aconselhamos sistema desmutiplicador, que por sua vez tem um valor acrescido, sendo esta uma opção do cliente.



CONTRA-PESO DECORATIVO



CONTRA-PESO INTERIOR (STANDART)



ENROLAMENTO EXTERIOR (STANDART)



ENROLAMENTO INTERIOR



SISTEMA DESMULTIPLICADOR
VALOR ACRESCIDO 56,65 €

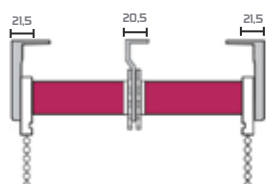

ESTOR DUPLO (PREÇO IGUAL AO DE DOIS ESTORES)

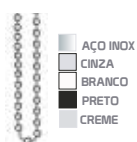

CORRENTE (COR STANDART: BRANCO)



CONTRA PESO CORRENTE
VALOR ACRESCIDO 1,48 €



TAMPAS E SUPORTES (COR STANDART: BRANCO)



VALOR ACRESCIDO 0,66€



VALOR ACRESCIDO 0,88 €

TENSORES DE CORRENTE

DISPOSITIVOS SEGURANÇA INFANTIL



NORMA EN 13120
SEGURANÇA CONTRA RISCOS DE ESTRANGULAMENTO
MAIS INFORMAÇÕES NO NOSSO CATÁLOGO GERAL

SISTEMA ROLO
Características técnicas

COLEÇÃO SCREEN DECOR

TABELA PREÇOS P.V.P €
iva não incluído

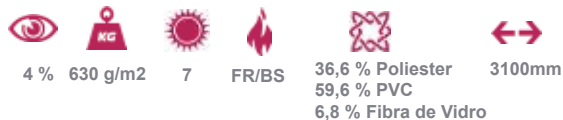

ALTURA	LARGURA												
	DIAM 40					DIAM 45							
	0,8	1,0	1,2	1,4	1,6	1,8	2,0	2,2	2,4	2,6	2,8	3,0	3,2
1,0	109,80	130,34	150,88	171,30	191,94	212,16	232,42	253,22	274,14	294,44	315,20	335,36	358,32
1,2	120,22	142,88	165,60	188,74	211,66	234,98	257,80	280,48	303,70	326,88	349,74	372,82	397,02
1,4	130,86	155,40	181,74	206,66	231,70	256,94	282,34	307,34	332,92	357,26	383,14	408,58	435,44
1,6	141,42	168,74	196,58	223,02	251,76	279,02	306,66	334,22	361,32	389,80	417,08	444,36	474,74
1,8	151,08	181,72	211,42	241,14	271,52	301,46	331,46	361,86	391,74	421,24	451,14	480,70	512,70
2,0	162,02	194,90	226,78	259,90	291,00	323,36	355,08	388,12	420,88	452,48	484,60	517,66	551,96
2,2	172,28	207,56	241,20	276,74	311,74	345,02	380,40	415,64	449,10	484,00	518,90	553,32	590,34
2,4	183,08	220,06	257,96	294,08	331,28	368,76	405,52	442,50	479,34	515,54	552,24	589,46	628,46
2,6	193,90	233,78	272,24	311,76	351,18	390,90	429,06	468,32	508,08	547,80	586,18	626,24	667,24
2,8	204,24	246,22	287,08	329,28	370,76	412,08	454,44	495,38	537,70	579,62	620,88	662,00	706,04
3,0	214,44	258,86	302,90	346,88	390,80	434,12	478,80	522,06	566,00	610,38	654,44	698,66	744,18
3,2	225,12	271,14	318,54	364,34	410,98	457,00	503,06	549,74	596,74	642,26	688,98	735,90	783,00

NOTA: A tela Screen Decor com largura acima de 3,10 metros terá que levar emenda.

Os estores são manuais com acionamento lateral de corrente branca e contra-peso interior (oculto). Nos preços com fundo de cor, aconselhamos sistema desmutiplicador, que por sua vez tem um valor acrescido, sendo esta uma opção do cliente.



CONTRA-PESO DECORATIVO



CONTRA-PESO INTERIOR (STANDART)



ENROLAMENTO EXTERIOR (STANDART)



ENROLAMENTO INTERIOR

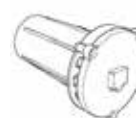

SISTEMA DESMULTIPLICADOR
VALOR ACRESCIDO 56,65 €

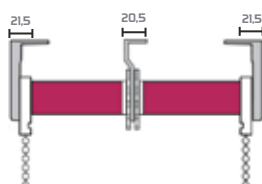

ESTOR DUPLO (PREÇO IGUAL AO DE DOIS ESTORES)

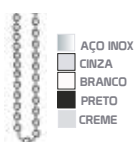

CORRENTE (COR STANDART: BRANCO)



CONTRA PESO CORRENTE
VALOR ACRESCIDO 1,48 €



TAMPAS E SUPORTES (COR STANDART: BRANCO)

DISPOSITIVOS SEGURANÇA INFANTIL



VALOR ACRESCIDO 0,66 €



VALOR ACRESCIDO 0,88 €



NORMA EN 13120
SEGURANÇA CONTRA RISCOS DE ESTRANGULAMENTO
MAIS INFORMAÇÕES NO NOSSO CATÁLOGO GERAL

TENSORES DE CORRENTE

SISTEMA ROLO

Características técnicas

COLEÇÃO ESTEIRA

TABELA PREÇOS P.V.P €
iva não incluído



ALTURA	LARGURA												
	DIAM 40							DIAM 45					
	0,8	1,0	1,2	1,4	1,6	1,8	2,0	2,2	2,4	2,6	2,8	3,0	3,2
1,0	49,56	56,74	64,00	71,24	78,40	85,22	92,88	100,34	107,86	114,30	121,66	129,60	138,92
1,2	52,94	59,50	67,88	75,64	83,32	91,56	98,44	103,60	114,90	122,74	130,70	137,32	147,08
1,4	54,90	63,14	71,64	79,76	88,38	96,78	104,72	113,58	121,74	129,02	138,32	146,48	157,88
1,6	57,44	66,66	74,32	83,22	92,80	102,04	110,66	119,36	128,66	137,94	146,70	155,44	166,86
1,8	59,88	69,88	78,56	88,04	97,54	107,80	116,54	126,38	135,34	145,44	154,02	164,90	176,04
2,0	62,22	72,30	82,40	92,78	102,10	112,42	122,68	132,02	142,22	152,36	162,56	173,32	185,32
2,2	65,00	75,74	86,38	96,66	107,62	117,48	128,20	139,56	149,56	160,04	171,12	181,24	194,64
2,4	67,74	78,12	89,42	100,32	112,90	123,32	134,98	145,90	156,96	168,00	179,20	190,88	203,98
2,6	69,70	82,08	93,88	105,90	116,78	128,26	140,24	152,10	163,34	175,66	187,04	199,72	213,34
2,8	72,34	84,44	97,34	109,12	121,44	134,12	146,22	158,66	171,08	183,18	195,88	208,06	222,70
3,0	74,50	87,62	101,22	113,66	126,08	139,98	152,34	165,62	178,30	191,38	203,40	216,74	231,78
3,2	77,38	91,02	104,08	117,74	131,80	145,06	158,90	171,74	179,90	198,10	212,64	225,50	241,44

NOTA: A tela Esteira com largura acima de 2,50 metros terá que levar emenda.

Os estores são manuais com acionamento lateral de corrente branca e contra-peso interior (oculto). Nos preços com fundo de cor, aconselhamos sistema desmultiplicador, que por sua vez tem um valor acrescido, sendo esta uma opção do cliente.



CONTRA-PESO
DECORATIVO



CONTRA-PESO
INTERIOR
(STANDART)



ENROLAMENTO
EXTERIOR
(STANDART)



ENROLAMENTO
INTERIOR

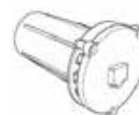

SISTEMA DESMULTIPLICADOR
VALOR ACRESCIDO 56,65 €

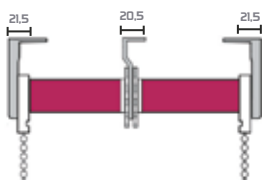

ESTOR DUPLO
(PREÇO IGUAL AO DE DOIS
ESTORES)

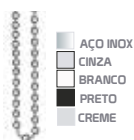

CORRENTE
(COR STANDART: BRANCO)



CONTRA PESO
CORRENTE
VALOR ACRESCIDO 1,48 €

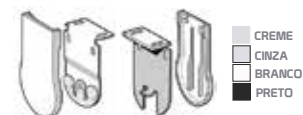

TAMPAS E SUPORTES
(COR STANDART: BRANCO)



VALOR ACRESCIDO 0,66 €



VALOR ACRESCIDO 0,88 €

TENSORES DE CORRENTE

DISPOSITIVOS SEGURANÇA INFANTIL



NORMA EN 13120
SEGURANÇA CONTRA RISCOS DE
ESTRANGULAMENTO
MAIS INFORMAÇÕES
NO NOSSO CATÁLOGO GERAL

SISTEMA ROLO
Características técnicas

COLEÇÃO SCREEN TÊXTIL

TABELA PREÇOS P.V.P €
iva não incluído



ALTURA	LARGURA												
	DIAM 40						DIAM 45						
	0,8	1,0	1,2	1,4	1,6	1,8	2,0	2,2	2,4	2,6	2,8	3,0	3,2
1,0	54,56	63,74	71,00	80,24	88,40	98,22	106,88	115,34	124,86	133,30	141,66	150,60	160,92
1,2	57,94	67,50	77,88	87,64	96,32	105,56	115,44	124,60	134,90	144,74	154,70	164,32	175,08
1,4	61,90	71,14	83,64	92,76	103,38	114,78	124,72	134,58	145,74	155,02	166,32	176,48	188,88
1,6	65,44	76,66	87,32	99,22	111,80	121,04	133,66	144,36	156,66	167,94	178,70	189,44	202,86
1,8	69,88	81,88	93,56	105,04	117,54	129,80	141,54	153,38	166,34	177,44	189,02	202,90	216,04
2,0	72,22	85,30	98,40	112,78	123,10	137,42	151,68	162,02	176,22	188,36	202,56	215,32	230,32
2,2	76,00	90,74	104,38	118,66	131,62	145,48	158,20	172,56	187,56	199,04	214,12	227,24	243,64
2,4	80,74	94,12	109,42	123,32	138,90	152,32	168,98	183,90	197,96	211,00	225,20	241,88	257,98
2,6	84,70	98,08	115,88	130,90	146,78	160,26	176,24	191,10	207,34	223,66	237,04	254,72	271,34
2,8	87,34	104,44	119,34	136,12	152,44	169,12	185,22	201,66	217,08	233,18	251,88	266,06	285,70
3,0	91,50	108,62	125,22	142,66	159,08	177,98	193,34	211,62	227,30	245,38	262,40	279,74	298,78
3,2	95,38	112,02	130,08	149,74	166,80	184,06	202,90	221,74	237,90	256,10	274,64	292,50	312,44

NOTA: A tela Screen Têxtil com largura acima de 3,00 metros terá que levar emenda.
Os estores são manuais com acionamento lateral de corrente branca e contra-peso interior (oculto).
Nos preços com fundo de cor, aconselhamos sistema desmultiplicador, que por sua vez tem um valor acrescido, sendo esta uma opção do cliente.



CONTRA-PESO
DECORATIVO



CONTRA-PESO
INTERIOR
(STANDART)



ENROLAMENTO
EXTERIOR
(STANDART)



ENROLAMENTO
INTERIOR



SISTEMA DESMULTIPLICADOR
VALOR ACRESCIDO 56,65 €

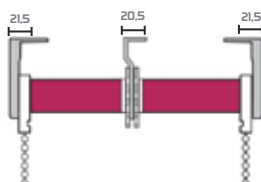

ESTOR DUPLO
(PREÇO IGUAL AO DE DOIS
ESTORES)



CORRENTE
(COR STANDART: BRANCO)



CONTRA PESO
CORRENTE
VALOR ACRESCIDO 1,48 €

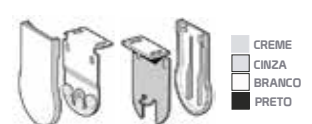

TAMPAS E SUPORTES
(COR STANDART: BRANCO)



VALOR ACRESCIDO 0,66 €



VALOR ACRESCIDO 0,88 €

TENSORES DE CORRENTE

DISPOSITIVOS SEGURANÇA INFANTIL



NORMA EN 13120
SEGURANÇA CONTRA RISCOS DE
ESTRANGULAMENTO
MAIS INFORMAÇÕES
NO NOSSO CATÁLOGO GERAL

SISTEMA ROLO
Características técnicas

COLEÇÃO SCREEN FANTASIA

TABELA PREÇOS P.V.P €
iva não incluído



ALTURA	DIAM 40								DIAM 45				
	0,8	1,0	1,2	1,4	1,6	1,8	2,0	2,2	2,4	2,6	2,8	3,0	3,2
1,0	62,80	72,34	83,88	93,30	103,94	114,16	125,42	135,22	145,14	156,44	167,20	177,36	190,32
1,2	66,22	78,88	89,60	101,74	112,66	124,98	136,80	147,48	159,70	170,88	183,74	194,82	207,02
1,4	71,86	83,40	96,74	109,66	122,70	134,94	147,34	160,34	172,92	184,26	198,14	210,58	225,44
1,6	75,42	90,74	103,58	116,02	131,76	144,02	158,66	172,22	185,32	199,80	213,08	226,36	242,74
1,8	80,08	94,72	110,42	124,14	139,52	155,46	169,46	184,86	199,74	212,24	228,14	243,70	260,70
2,0	85,02	101,90	117,78	133,90	148,00	165,36	180,08	195,12	213,88	228,48	243,60	260,66	278,96
2,2	89,28	107,56	123,20	141,74	158,74	174,02	191,40	208,64	225,10	242,00	259,90	276,32	294,34
2,4	94,08	113,06	131,96	148,08	167,28	185,76	203,52	220,50	238,34	257,54	274,24	293,46	312,46
2,6	100,90	119,78	138,24	157,76	175,18	195,90	213,06	233,32	251,08	271,80	289,18	309,24	329,24
2,8	104,24	124,22	144,08	165,28	185,76	205,08	224,44	245,38	265,70	285,62	305,88	325,00	347,04
3,0	109,44	131,86	152,90	173,88	194,80	215,12	236,80	258,06	278,00	300,38	320,44	342,66	364,18
3,2	114,12	136,14	159,54	180,34	203,98	224,00	247,06	269,74	292,74	314,26	336,98	359,90	382,00

NOTA: A tela Screen Fantasia com largura acima de 2,50 metros terá que levar emenda.
Os estores são manuais com acionamento lateral de corrente branca e contra-peso interior (oculto).
Nos preços com fundo de cor, aconselhamos sistema desmultiplicador, que por sua vez tem um valor acrescido, sendo esta uma opção do cliente.



CONTRA-PESO
DECORATIVO



CONTRA-PESO
INTERIOR
(STANDART)



ENROLAMENTO
EXTERIOR
(STANDART)



ENROLAMENTO
INTERIOR

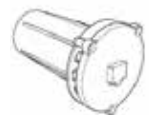

SISTEMA DESMULTIPLICADOR
VALOR ACRESCIDO 56,65 €

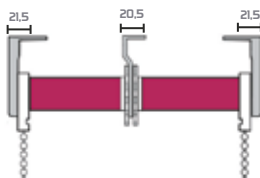

ESTOR DUPLO
(PREÇO IGUAL AO DE DOIS
ESTORES)



CORRENTE
(COR STANDART: BRANCO)



CONTRA PESO
CORRENTE
VALOR ACRESCIDO 1,48 €

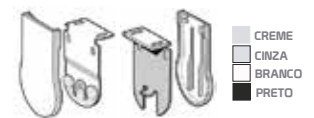

TAMPAS E SUPORTES
(COR STANDART: BRANCO)



VALOR ACRESCIDO 0,66 €



VALOR ACRESCIDO 0,88 €

TENSORES DE CORRENTE

DISPOSITIVOS SEGURANÇA INFANTIL



NORMA EN 13120
SEGURANÇA CONTRA RISCOS DE
ESTRANGULAMENTO
MAIS INFORMAÇÕES
NO NOSSO CATÁLOGO GERAL

SISTEMA ROLO

Características técnicas



COLEÇÃO SCREEN SOLAR

TABELA PREÇOS P.V.P €

iva não incluído

ALTURA	DIAM 40								DIAM 45			
	0,8	1,0	1,2	1,4	1,6	1,8	2,0	2,2	2,4	2,6	2,8	3,0
1,0	104,80	124,34	144,88	164,30	183,94	203,16	223,42	243,22	263,14	283,44	303,20	323,36
1,2	114,22	137,88	159,60	181,74	203,66	225,98	247,80	270,48	292,70	314,88	336,74	358,82
1,4	125,86	149,40	174,74	198,66	223,70	247,94	272,34	296,34	321,92	345,26	370,14	394,58
1,6	135,42	162,74	189,58	215,02	242,76	269,02	296,66	323,22	349,32	376,80	403,08	430,36
1,8	145,08	174,72	204,42	233,14	262,52	291,46	320,46	349,86	378,74	407,24	436,14	466,70
2,0	156,02	187,90	219,78	250,90	281,00	313,36	344,08	376,12	407,88	438,48	470,60	501,66
2,2	166,28	200,56	233,20	267,74	301,74	335,02	368,40	402,64	436,10	470,00	503,90	537,32
2,4	176,08	213,06	248,96	285,08	320,28	357,76	393,52	429,50	465,34	501,54	537,24	573,46
2,6	187,90	225,78	263,24	302,76	340,18	378,90	417,06	455,32	494,08	532,80	570,18	609,24
2,8	197,24	238,22	278,08	319,28	360,76	400,08	441,44	482,38	522,70	563,62	603,88	644,50
3,0	208,44	251,86	293,90	336,88	379,80	422,12	465,80	508,06	551,00	594,38	637,44	680,66
3,2	218,12	263,14	308,54	354,34	399,98	444,00	489,06	534,74	580,74	625,26	670,98	715,90

NOTA: A tela Screen Solar com largura acima de 2,40 metros terá que levar emenda.

Os estores são manuais com acionamento lateral de corrente branca e contra-peso interior (oculto). Nos preços com fundo de cor, aconselhamos sistema desmutiplicador, que por sua vez tem um valor acrescido, sendo esta uma opção do cliente.



CONTRA-PESO DECORATIVO



CONTRA-PESO INTERIOR (STANDART)



ENROLAMENTO EXTERIOR (STANDART)



ENROLAMENTO INTERIOR



SISTEMA DESMULTIPLICADOR
VALOR ACRESCIDO 56,65 €

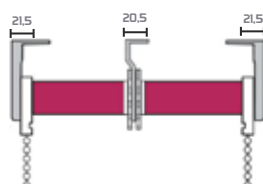

ESTOR DUPLO (PREÇO IGUAL AO DE DOIS ESTORES)



CORRENTE (COR STANDART: BRANCO)



CONTRA PESO CORRENTE
VALOR ACRESCIDO 1,48 €



TAMPAS E SUPORTES (COR STANDART: BRANCO)

DISPOSITIVOS SEGURANÇA INFANTIL



VALOR ACRESCIDO 0,66 €



VALOR ACRESCIDO 0,88 €

TENSORES DE CORRENTE



NORMA EN 13120

SEGURANÇA CONTRA RISCOS DE ESTRANGULAMENTO
MAIS INFORMAÇÕES NO NOSSO CATÁLOGO GERAL



ALTURA	DIAM 40								DIAM 45			
	0,8	1,0	1,2	1,4	1,6	1,8	2,0	2,2	2,4	2,6	2,8	3,0
1,0	104,80	124,34	144,88	164,30	183,94	203,16	223,42	243,22	263,14	283,44	303,20	323,36
1,2	114,22	137,88	159,60	181,74	203,66	225,98	247,80	270,48	292,70	314,88	336,74	358,82
1,4	125,86	149,40	174,74	198,66	223,70	247,94	272,34	296,34	321,92	345,26	370,14	394,58
1,6	135,42	162,74	189,58	215,02	242,76	269,02	296,66	323,22	349,32	376,80	403,08	430,36
1,8	145,08	174,72	204,42	233,14	262,52	291,46	320,46	349,86	378,74	407,24	436,14	466,70
2,0	156,02	187,90	219,78	250,90	281,00	313,36	344,08	376,12	407,88	438,48	470,60	501,66
2,2	166,28	200,56	233,20	267,74	301,74	335,02	368,40	402,64	436,10	470,00	503,90	537,32
2,4	176,08	213,06	248,96	285,08	320,28	357,76	393,52	429,50	465,34	501,54	537,24	573,46
2,6	187,90	225,78	263,24	302,76	340,18	378,90	417,06	455,32	494,08	532,80	570,18	609,24
2,8	197,24	238,22	278,08	319,28	360,76	400,08	441,44	482,38	522,70	563,62	603,88	644,50
3,0	208,44	251,86	293,90	336,88	379,80	422,12	465,80	508,06	551,00	594,38	637,44	680,66
3,2	218,12	263,14	308,54	354,34	399,98	444,00	489,06	534,74	580,74	625,26	670,98	715,90

NOTA: A tela Blackout Solar com largura acima de 2,40 metros terá que levar emenda.

Os estores são manuais com acionamento lateral de corrente branca e contra-peso interior (oculto). Nos preços com fundo de cor, aconselhamos sistema desmultiplicador, que por sua vez tem um valor acrescido, sendo esta uma opção do cliente.



CONTRA-PESO
DECORATIVO



CONTRA-PESO
INTERIOR
(STANDART)



ENROLAMENTO
EXTERIOR
(STANDART)



ENROLAMENTO
INTERIOR



SISTEMA DESMULTIPLICADOR
VALOR ACRESCIDO 56,65 €

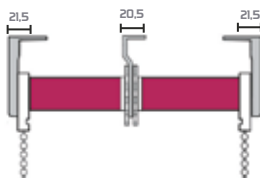

ESTOR DUPLO
(PREÇO IGUAL AO DE DOIS
ESTORES)



CORRENTE
(COR STANDART: BRANCO)



CONTRA PESO
CORRENTE
VALOR ACRESCIDO 1,48 €

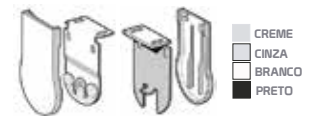

TAMPAS E SUPORTES
(COR STANDART: BRANCO)



VALOR ACRESCIDO 0,66 €



VALOR ACRESCIDO 0,88 €

TENSORES DE CORRENTE

DISPOSITIVOS SEGURANÇA INFANTIL



NORMA EN 13120
SEGURANÇA CONTRA RISCOS DE
ESTRANGULAMENTO
MAIS INFORMAÇÕES
NO NOSSO CATÁLOGO GERAL

SISTEMA ROLO

Características técnicas

COLEÇÃO SHANTUNG BLACKOUT

TABELA PREÇOS P.V.P €
iva não incluído



ALTURA	LARGURA								LARGURA				
	DIAM 40								DIAM 45				
	0,8	1,0	1,2	1,4	1,6	1,8	2,0	2,2	2,4	2,6	2,8	3,0	3,2
1,0	59,80	68,34	76,88	85,30	94,94	103,16	112,42	121,22	130,14	138,44	147,20	156,36	167,32
1,2	62,22	72,88	81,60	91,74	100,66	110,98	120,80	129,48	139,70	148,88	158,74	167,82	179,92
1,4	65,86	76,40	86,74	96,66	106,70	117,94	127,34	137,34	148,92	158,26	168,14	179,58	191,44
1,6	69,42	80,74	91,58	102,02	113,76	124,02	135,66	146,22	157,32	168,80	179,08	190,36	203,74
1,8	72,08	84,72	95,42	107,14	119,52	131,46	142,46	154,86	166,74	178,24	189,14	201,70	215,70
2,0	75,02	88,90	100,78	113,90	125,00	137,36	150,08	162,12	175,88	187,48	200,60	212,66	227,96
2,2	78,28	92,56	105,20	118,74	131,74	144,02	158,40	171,64	184,10	197,00	210,90	224,32	239,34
2,4	82,08	96,06	109,96	123,08	137,28	151,76	165,52	179,50	193,34	207,54	221,24	235,46	251,46
2,6	85,90	100,78	114,24	129,76	143,18	158,90	173,06	187,32	202,08	217,80	231,18	246,24	263,24
2,8	88,24	104,22	119,08	134,28	150,76	165,08	180,44	196,38	211,70	226,62	242,88	257,80	275,04
3,0	91,44	108,86	124,90	140,88	156,80	172,12	188,80	204,06	221,00	236,38	252,44	269,66	287,18
3,2	95,12	112,14	128,54	145,34	162,98	179,00	196,06	212,74	229,74	246,26	263,98	280,90	299,40

NOTA: A tela Shantung Blackout com largura acima de 3,00 metros terá que levar emenda.
Os estores são manuais com acionamento lateral de corrente branca e contra-peso interior (oculto).
Nos preços com fundo de cor, aconselhamos sistema desmultiplicador, que por sua vez tem um valor acrescido, sendo esta uma opção do cliente.



CONTRA-PESO DECORATIVO



CONTRA-PESO INTERIOR (STANDART)



ENROLAMENTO EXTERIOR (STANDART)



ENROLAMENTO INTERIOR



SISTEMA DESMULTIPLICADOR
VALOR ACRESCIDO 56,65 €

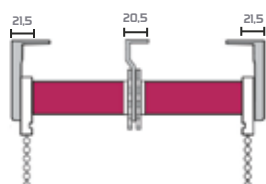

ESTOR DUPLO (PREÇO IGUAL AO DE DOIS ESTORES)

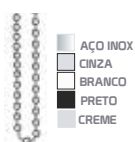

CORRENTE (COR STANDART: BRANCO)



CONTRA PESO CORRENTE
VALOR ACRESCIDO 1,48 €

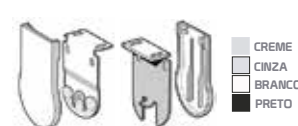

TAMPAS E SUPORTES (COR STANDART: BRANCO)

DISPOSITIVOS SEGURANÇA INFANTIL



VALOR ACRESCIDO 0,66 €



VALOR ACRESCIDO 0,88 €



NORMA EN 13120
SEGURANÇA CONTRA RISCOS DE ESTRANGULAMENTO
MAIS INFORMAÇÕES NO NOSSO CATÁLOGO GERAL

TENSORES DE CORRENTE

SISTEMA ROLO

Características técnicas

COLEÇÃO LINHO BLACKOUT

TABELA PREÇOS P.V.P €
iva não incluído



ALTURA	LARGURA												
	DIAM 40						DIAM 45						
	0,8	1,0	1,2	1,4	1,6	1,8	2,0	2,2	2,4	2,6	2,8	3,0	3,2
1,0	51,72	59,74	67,90	74,28	82,22	90,76	98,44	105,88	113,30	120,46	129,30	136,26	146,20
1,2	54,90	63,66	71,24	80,04	88,44	96,18	104,74	113,80	120,72	130,82	138,26	146,08	156,62
1,4	57,86	66,40	75,94	84,66	93,70	102,94	111,34	119,84	129,92	138,26	147,44	156,58	167,44
1,6	60,42	69,74	79,98	88,62	98,76	108,02	118,66	126,22	137,32	147,80	156,64	166,36	177,74
1,8	62,08	73,12	83,42	93,84	104,52	114,86	125,46	134,86	144,94	154,74	164,94	175,80	188,70
2,0	65,92	77,90	88,78	98,90	109,20	119,86	130,08	142,32	153,88	164,48	174,60	186,66	198,96
2,2	68,28	80,96	91,20	103,74	115,74	125,02	137,40	150,64	160,10	172,00	184,90	195,32	209,34
2,4	71,08	83,06	96,96	108,28	119,78	132,76	144,52	157,50	169,34	180,54	192,84	205,46	219,46
2,6	75,90	87,78	100,24	113,76	124,18	138,90	150,06	164,32	176,28	190,80	202,18	214,24	229,24
2,8	77,24	90,22	104,08	117,28	131,76	144,08	158,44	171,38	184,70	198,62	212,88	224,60	240,04
3,0	79,44	94,86	109,90	122,88	136,80	150,52	163,80	178,06	192,60	206,38	220,44	234,66	250,18
3,2	82,52	96,94	112,54	127,34	142,98	155,60	171,06	186,74	200,74	214,56	230,98	245,90	260,60

NOTA: A tela Linho Blackout com largura acima de 2,10 metros terá que levar emenda.

Os estores são manuais com acionamento lateral de corrente branca e contra-peso interior (oculto). Nos preços com fundo de cor, aconselhamos sistema desmutiplicador, que por sua vez tem um valor acrescido, sendo esta uma opção do cliente.



CONTRA-PESO
DECORATIVO



CONTRA-PESO
INTERIOR
(STANDART)



ENROLAMENTO
EXTERIOR
(STANDART)



ENROLAMENTO
INTERIOR



SISTEMA DESMULTIPLICADOR
VALOR ACRESCIDO 56,65 €

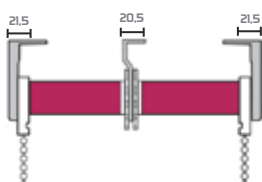

ESTOR DUPLO
(PREÇO IGUAL AO DE DOIS
ESTORES)

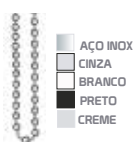

CORRENTE
(COR STANDART: BRANCO)



CONTRA PESO
CORRENTE
VALOR ACRESCIDO 1,48 €

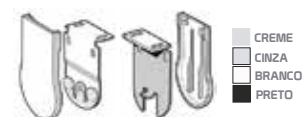

TAMPAS E SUPORTES
(COR STANDART: BRANCO)



VALOR ACRESCIDO 0,66 €



VALOR ACRESCIDO 0,88 €

TENSORES DE CORRENTE

DISPOSITIVOS SEGURANÇA INFANTIL



NORMA EN 13120
SEGURANÇA CONTRA RISCOS DE
ESTRANGULAMENTO
MAIS INFORMAÇÕES
NO NOSSO CATÁLOGO GERAL

SISTEMA ROLO
Características técnicas

COLEÇÃO LINHO

TABELA PREÇOS P.V.P €
iva não incluído



ALTURA	DIAM 40								DIAM 45				
	0,8	1,0	1,2	1,4	1,6	1,8	2,0	2,2	2,4	2,6	2,8	3,0	3,2
1,0	37,44	42,78	48,18	53,82	59,00	63,86	69,74	75,10	81,24	85,52	91,32	96,04	103,68
1,2	40,04	44,52	51,80	56,62	62,48	68,48	74,02	79,82	85,96	91,46	97,08	103,08	110,98
1,4	40,58	47,14	53,26	59,62	65,82	72,02	78,50	84,58	90,64	97,72	103,10	109,86	117,30
1,6	42,70	50,02	56,06	62,74	69,18	75,54	82,76	89,56	95,92	102,38	108,68	115,64	124,52
1,8	45,14	52,42	59,70	65,86	72,72	79,92	87,20	94,02	100,84	107,18	115,32	122,00	130,40
2,0	47,20	53,74	61,46	68,42	76,58	83,50	91,22	98,76	105,16	113,86	121,32	128,86	137,38
2,2	48,62	56,44	63,96	71,34	79,52	87,58	94,98	103,32	110,28	118,80	127,66	133,96	144,10
2,4	50,36	58,68	66,38	74,34	83,76	91,56	99,36	108,08	116,74	123,62	132,90	140,08	150,84
2,6	51,72	60,88	69,54	77,80	86,64	95,58	104,04	112,76	121,80	130,62	138,06	148,74	157,90
2,8	54,98	62,82	71,16	80,42	90,94	99,42	108,38	117,30	126,22	135,06	144,34	154,98	164,52
3,0	56,76	65,74	74,46	83,50	93,78	103,06	113,56	122,66	131,76	140,00	150,50	160,24	171,08
3,2	58,26	67,00	77,28	87,68	97,40	107,80	116,40	126,78	136,68	147,82	156,90	166,74	177,60

NOTA: A tela Linho com largura acima de 2,10 metros terá que levar emenda.

Os estores são manuais com acionamento lateral de corrente branca e contra-peso interior (oculto). Nos preços com fundo de cor, aconselhamos sistema desmultiplicador, que por sua vez tem um valor acrescido, sendo esta uma opção do cliente.



CONTRA-PESO DECORATIVO



CONTRA-PESO INTERIOR (STANDART)



ENROLAMENTO EXTERIOR (STANDART)



ENROLAMENTO INTERIOR



SISTEMA DESMULTIPLICADOR
VALOR ACRESCIDO 56,65 €

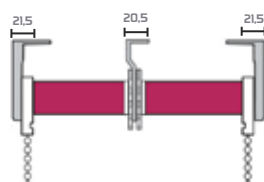

ESTOR DUPLO (PREÇO IGUAL AO DE DOIS ESTORES)

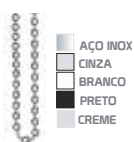

CORRENTE (COR STANDART: BRANCO)



CONTRA PESO CORRENTE
VALOR ACRESCIDO 1,48 €



TAMPAS E SUPORTES (COR STANDART: BRANCO)

DISPOSITIVOS SEGURANÇA INFANTIL



VALOR ACRESCIDO 0,66 €



VALOR ACRESCIDO 0,88 €



NORMA EN 13120
SEGURANÇA CONTRA RISCOS DE ESTRANGULAMENTO
MAIS INFORMAÇÕES NO NOSSO CATÁLOGO GERAL

SISTEMA ROLO
Características técnicas

COLEÇÃO MICRO SHANTUNG

TABELA PREÇOS P.V.P €
iva não incluído



ALTURA	LARGURA												
	DIAM 40						DIAM 45						
	0,8	1,0	1,2	1,4	1,6	1,8	2,0	2,2	2,4	2,6	2,8	3,0	3,2
1,0	44,80	50,34	56,88	63,30	68,94	75,16	81,42	87,22	93,54	99,44	105,20	112,36	120,32
1,2	46,22	52,88	59,60	66,74	72,66	79,98	85,80	92,48	98,70	105,88	112,74	118,82	128,02
1,4	48,86	55,40	62,74	69,66	76,70	83,94	90,34	97,34	104,92	111,26	118,14	125,58	134,44
1,6	50,42	57,74	64,58	72,02	79,76	87,02	94,66	102,22	109,32	116,80	124,08	131,36	141,74
1,8	52,08	59,72	67,42	75,64	83,52	91,46	99,46	107,86	114,74	122,24	130,14	138,70	148,70
2,0	53,02	62,90	70,78	78,90	87,00	95,36	103,08	111,12	120,88	128,48	136,60	145,66	155,96
2,2	55,28	64,56	73,20	82,74	90,74	99,52	108,40	116,64	125,10	134,10	143,90	151,32	162,34
2,4	57,08	67,06	76,96	85,08	94,28	103,76	112,52	121,50	131,34	140,54	149,24	158,46	169,46
2,6	59,90	69,78	78,24	88,76	98,18	107,90	117,06	126,32	136,08	145,80	155,18	165,24	176,24
2,8	61,24	71,22	82,08	91,28	101,76	112,08	121,44	131,38	141,70	151,62	161,88	172,00	184,04
3,0	63,44	74,86	84,90	94,88	105,80	115,12	126,80	137,06	147,00	157,38	168,44	178,66	191,18
3,2	66,12	76,14	87,54	98,34	108,98	119,00	131,06	141,74	152,74	163,26	174,98	185,90	198,00

NOTA: A tela Micro Shantung com largura acima de 2,50 metros terá que levar emenda.
Os estores são manuais com acionamento lateral de corrente branca e contra-peso interior (oculto).
Nos preços com fundo de cor, aconselhamos sistema desmutiplicador, que por sua vez tem um valor acrescido, sendo esta uma opção do cliente.



CONTRA-PESO
DECORATIVO



CONTRA-PESO
INTERIOR
(STANDART)



ENROLAMENTO
EXTERIOR
(STANDART)



ENROLAMENTO
INTERIOR



SISTEMA DESMUTIPICADOR
VALOR ACRESCIDO 56,65 €

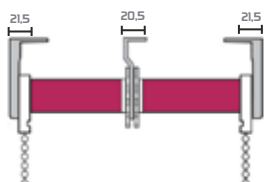

ESTOR DUPLO
(PREÇO IGUAL AO DE DOIS
ESTORES)

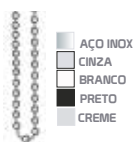

CORRENTE
(COR STANDART: BRANCO)



CONTRA PESO
CORRENTE
VALOR ACRESCIDO 1,48 €

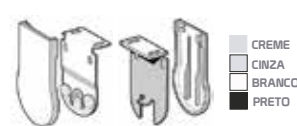

TAMPAS E SUPORTES
(COR STANDART: BRANCO)



VALOR ACRESCIDO 0,66 €



VALOR ACRESCIDO 0,88 €

TENSORES DE CORRENTE

DISPOSITIVOS SEGURANÇA INFANTIL



NORMA EN 13120
SEGURANÇA CONTRA RISCOS DE
ESTRANGULAMENTO
MAIS INFORMAÇÕES
NO NOSSO CATÁLOGO GERAL

SISTEMA ROLO
Características técnicas

COLEÇÃO SHANTUNG

TABELA PREÇOS P.V.P €
iva não incluído



ALTURA	LARGURA											
	DIAM 40						DIAM 45					
	0,8	1,0	1,2	1,4	1,6	1,8	2	2,2	2,4	2,6	2,8	3
1,0	38,54	43,84	49,78	54,84	60,28	65,00	70,76	77,90	82,88	86,54	92,36	97,24
1,2	41,88	46,22	51,82	57,98	63,66	69,48	75,86	80,48	86,46	92,80	97,24	103,08
1,4	42,40	48,76	54,70	60,88	66,90	73,92	78,62	84,60	90,70	97,86	103,10	109,66
1,6	43,46	50,56	57,42	63,90	69,18	75,54	82,74	89,96	94,88	102,40	108,52	115,28
1,8	46,82	52,90	59,96	66,94	72,60	79,98	87,66	92,98	100,90	107,26	114,96	120,94
2,0	47,82	53,78	61,66	68,42	75,54	82,46	90,56	97,88	104,10	111,54	119,78	127,86
2,2	48,42	56,44	64,10	71,26	78,50	86,52	93,98	102,32	109,26	116,70	125,66	131,96
2,4	50,90	58,88	66,38	74,16	82,76	90,88	98,36	107,94	115,74	121,02	130,90	138,00
2,6	51,72	59,90	68,54	76,54	85,12	94,58	102,04	110,46	119,80	127,62	134,06	143,74
2,8	54,98	62,02	71,18	79,06	89,94	97,42	106,38	114,70	124,22	132,06	141,34	150,98
3,0	55,76	64,74	73,48	82,40	92,78	101,06	109,56	119,66	128,76	137,00	146,40	155,24
3,2	57,26	66,00	75,22	86,68	95,40	104,80	113,30	122,78	133,68	142,82	152,90	161,74

NOTA: A tela Shantung com largura acima de 2,00 metros terá que levar emenda.
Os estores são manuais com acionamento lateral de corrente branca e contra-peso interior (oculto).
Nos preços com fundo de cor, aconselhamos sistema desmultiplicador, que por sua vez tem um valor acrescido, sendo esta uma opção do cliente.



CONTRA-PESO
DECORATIVO



CONTRA-PESO
INTERIOR
(STANDART)



ENROLAMENTO
EXTERIOR
(STANDART)



ENROLAMENTO
INTERIOR



SISTEMA DESMULTIPLICADOR
VALOR ACRESCIDO 56,65 €

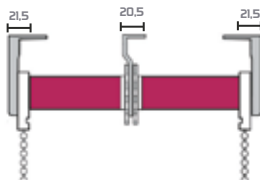

ESTOR DUPLO
(PREÇO IGUAL AO DE DOIS
ESTORES)



CORRENTE
(COR STANDART: BRANCO)



CONTRA PESO
CORRENTE
VALOR ACRESCIDO 1,48 €



TAMPAS E SUPORTES
(COR STANDART: BRANCO)

DISPOSITIVOS SEGURANÇA INFANTIL



VALOR ACRESCIDO 0,66 €



VALOR ACRESCIDO 0,88 €



NORMA EN 13120
SEGURANÇA CONTRA RISCOS DE
ESTRANGULAMENTO
MAIS INFORMAÇÕES
NO NOSSO CATÁLOGO GERAL

SISTEMA ROLO

Características técnicas

COLEÇÃO NOITE / DIA

TABELA PREÇOS P.V.P €
iva não incluído



LARGURA

		LARGURA										
		0,6	0,8	1,0	1,2	1,4	1,6	1,8	2,0	2,2	2,4	
ALTURA	CAIXA 73MM	1,0	97,20	102,34	106,58	111,06	118,66	122,60	127,34	132,72	137,14	141,20
		1,2	109,66	115,76	119,80	124,54	130,92	134,32	139,40	145,52	150,96	154,44
		1,4	123,44	127,60	131,00	136,88	142,42	147,78	152,80	158,82	162,28	167,90
		1,6	135,90	139,88	144,42	149,60	155,30	159,14	164,54	170,36	174,66	180,90
		1,8	147,30	152,66	157,80	161,44	167,88	172,36	177,90	182,40	187,78	192,92
		2,0	159,22	164,40	169,44	173,74	180,88	184,42	189,56	195,18	200,68	204,54
		2,2	172,66	176,24	182,74	186,70	192,54	197,50	201,66	207,22	212,50	216,42
		2,4	184,20	189,68	194,54	199,50	204,24	209,20	213,60	220,60	224,22	229,46
		2,6	197,82	202,90	206,58	211,08	217,02	221,60	226,90	232,42	237,50	241,18
		2,8	210,90	214,46	219,90	223,72	230,40	234,28	238,94	245,90	250,98	253,48
	3,0	222,88	227,98	231,94	236,20	242,00	246,12	252,80	257,56	261,60	265,24	

NOTA: Os estores são manuais com acionamento lateral de corrente branca e contra-peso visível.
Nos preços com fundo de cor, aconselhamos sistema desmultiplicador, que por sua vez tem um valor acrescido, sendo esta uma opção do cliente.

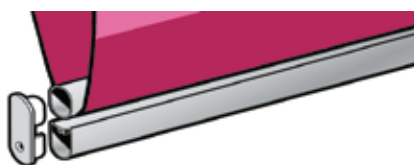

CONTRA-PESO
VISÍVEL

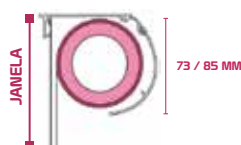

ENROLAMENTO
EXTERIOR

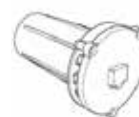

SISTEMA DESMULTIPLICADOR
VALOR ACRESCIDO 56,65 €



CORRENTE
(COR STANDART: BRANCO)



CONTRA PESO
CORRENTE
VALOR ACRESCIDO 1,48 €

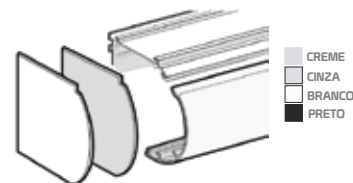

CAIXA 73/85 MM
(COR STANDART: BRANCO)
CAIXA 85MM APENAS EM BRANCO

DISPOSITIVOS SEGURANÇA INFANTIL



VALOR ACRESCIDO 0,66 €



VALOR ACRESCIDO 0,88 €

TENSORES DE CORRENTE



NORMA EN 13120
SEGURANÇA CONTRA RISCOS DE
ESTRANGULAMENTO
MAIS INFORMAÇÕES
NO NOSSO CATÁLOGO GERAL

SISTEMA DE ROLO MOTORIZADO

PREÇOS P.V.P €
iva não incluido

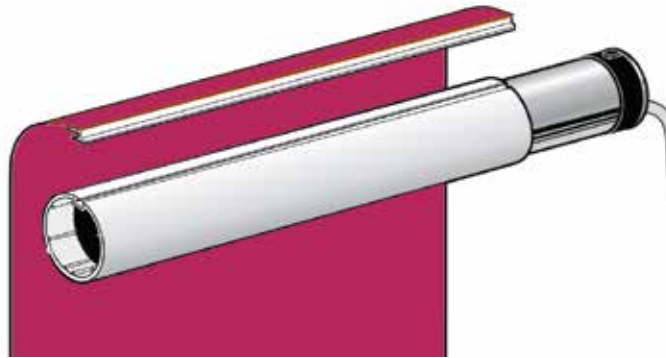

NOTA: Todos os valores abaixo são valores acrescidos à tabela do sistema de rolo manual.



MOTOR COM RECETOR
PARA TELECOMANDO
180,92 €



MOTOR PARA LIGAÇÃO
220V
106,76 €

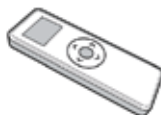

COMANDO 1 CANAL
31,98 €

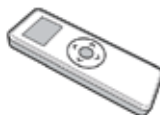

COMANDO 4 CANAIS
54,78€

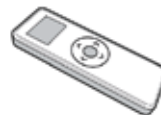

COMANDO 8 CANAIS
59,68 €

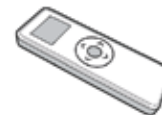

COMANDO 16 CANAIS
101,88 €



INTERRUPTOR PAREDE
1 CANAL
63,74 €

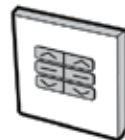

INTERRUPTOR PAREDE
2 CANAIS
69,90 €



CONTRA-PESO
DECORATIVO



CONTRA-PESO
INTERIOR
(STANDART)



ENROLAMENTO
EXTERIOR
(STANDART)



ENROLAMENTO
INTERIOR

SISTEMA DE CAIXAS E GUIAS

TABELA PREÇOS P.V.P €
iva não incluído



SUPORE PAREDE
CAIXA DE 80MM



PREÇO
2,88 €/Uni.

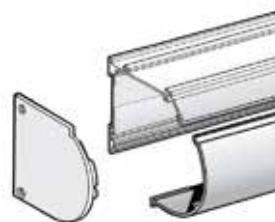

CAIXA DE 80MM



LARGURA

CAIXA DE 80MM	1,0	1,2	1,4	1,6	1,8	2,0	2,2	2,4	2,6	2,8	3,0	3,2
	33,14	39,56	46,40	52,92	59,68	66,28	72,82	79,44	87,58	92,72	99,42	105,96

NOTA: Não inclui suportes de parede, guias laterais nem contrapeso.



SUPORE PAREDE
CAIXA DE 90MM



PREÇO
2,94 €/Uni.

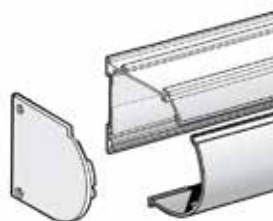

CAIXA DE 90MM



LARGURA

CAIXA DE 90MM	1,0	1,2	1,4	1,6	1,8	2,0	2,2	2,4	2,6	2,8	3,0	3,2
	91,58	109,40	127,72	146,74	164,46	182,16	200,88	218,90	237,32	255,04	273,74	291,96

NOTA: Não inclui suportes de parede, guias laterais nem contrapeso.



GUIAS LATERAIS
60X27



ALTURA

GUIAS LATERAIS	1,0	1,2	1,4	1,6	1,8	2,0	2,2	2,4	2,6	2,8	3,0	3,2
	34,90	41,98	48,86	55,84	62,82	69,80	76,88	83,86	90,14	97,92	104,70	111,48

NOTA: Os preços acima são de 1 conjunto de guias (PAR), não inclui contrapeso.



CONTRA-PESO EXTERIOR PARA GUIAS LATERAIS.

PREÇO
11,22€/Mt

NOTA: Acréscimo em aplicações de guias laterais

SISTEMA DE MANIVELA E CABO AÇO

PREÇOS P.V.P €
iva não incluído

NOTA: Todos os valores abaixo são valores acrescidos à tabela do sistema de rolo manual.

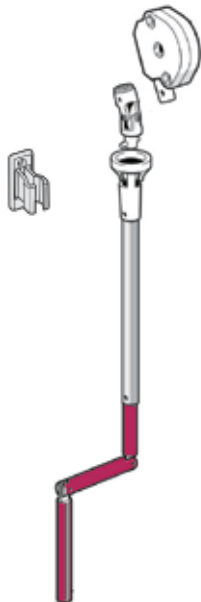

SISTEMA DE MANIVELA AMOVÍVEL
PREÇO
107,90 €

Inclui :

- suportes
- kit manivela amovível
- tubo
- contra-peso

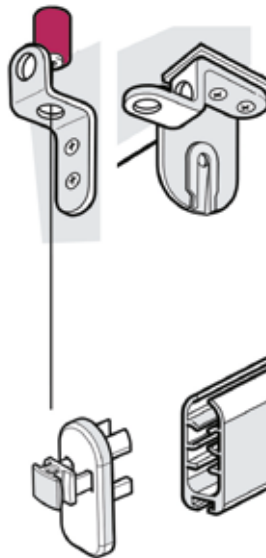

SISTEMA CABO DE AÇO 1,0MM INTERIOR
PREÇO
21,60 €

Inclui :

- suportes
- 1 conjunto de 2 cabos de aço até 3 metros de altura
- fixadores de cabos



SISTEMA CABO DE AÇO 5,0MM EXTERIOR
PREÇO
297,40 €

Inclui :

- tubo 78mm
- suportes
- varão contra-peso
- 1 conjunto de 2 cabos de aço até 3m de altura
- fixadores de cabos



SISTEMA MINIBOX

SISTEMA MINIBOX

Características técnicas



COLEÇÃO ÍRIS

TABELA PREÇOS P.V.P €
iva não incluído

SISTEMA DE CORRENTE

LARGURA

		0,8	1,0	1,2
ALTURA	1,0	95,80	101,20	117,84
	1,2	97,54	102,88	121,98
	1,4	98,96	105,42	122,96
	1,6	101,06	108,32	125,78
	1,8	103,12	110,56	129,62

SISTEMA DE MOLLA

LARGURA

		0,8	1,0	1,2
ALTURA	1,0	202,34	207,54	212,78
	1,2	204,88	209,22	215,62
	1,4	205,40	211,76	218,70
	1,6	207,46	214,56	220,42
	1,8	209,82	217,90	224,96

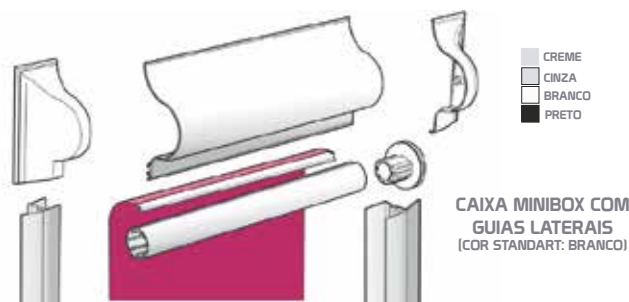

DISPOSITIVOS SEGURANÇA INFANTIL



NORMA EN 13120
SEGURANÇA CONTRA RISCOS DE ESTRANGULAMENTO
MAIS INFORMAÇÕES NO NOSSO CATÁLOGO GERAL

TENSORES DE CORRENTE

SISTEMA MINIBOX

Características técnicas



COLEÇÃO ALCOA

TABELA PREÇOS P.V.P €
iva não incluído

SISTEMA DE CORRENTE

LARGURA

		LARGURA		
		0,8	1,0	1,2
ALTURA	1,0	110,90	119,48	139,12
	1,2	114,48	124,54	144,02
	1,4	117,94	128,28	149,96
	1,6	121,32	132,40	154,86
	1,8	124,98	135,88	159,78

SISTEMA DE MOLA

LARGURA

		LARGURA		
		0,8	1,0	1,2
ALTURA	1,0	216,24	226,82	234,22
	1,2	221,82	230,88	239,24
	1,4	223,28	234,62	243,88
	1,6	228,66	238,74	248,56
	1,8	231,62	242,22	254,62

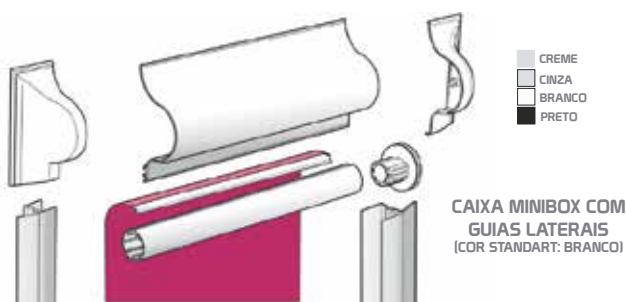

DISPOSITIVOS SEGURANÇA INFANTIL



TENSORES DE CORRENTE



NORMA EN 13120
SEGURANÇA CONTRA RISCOS DE ESTRANGULAMENTO
MAIS INFORMAÇÕES NO NOSSO CATÁLOGO GERAL

SISTEMA MINIBOX

Características técnicas

5 %
 415 g/m2
 7
 M1
 70 % Poliéster
30 % PVC
 3000mm

COLEÇÃO SCREEN 3500

TABELA PREÇOS P.V.P €
iva não incluído

SISTEMA DE CORRENTE LARGURA

		LARGURA		
		0,8	1,0	1,2
ALTURA	1,0	112,22	121,40	141,58
	1,2	116,90	125,86	147,82
	1,4	120,56	129,72	152,56
	1,6	123,70	135,32	157,92
	1,8	128,54	139,64	163,56

SISTEMA DE MOLA LARGURA

		LARGURA		
		0,8	1,0	1,2
ALTURA	1,0	218,56	228,74	235,00
	1,2	222,24	232,50	241,88
	1,4	226,90	235,06	247,64
	1,6	230,44	241,66	252,32
	1,8	234,88	246,88	258,56

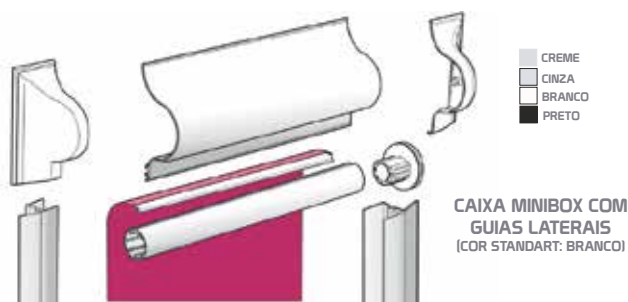

TENSORES DE CORRENTE

DISPOSITIVOS SEGURANÇA INFANTIL



NORMA EN 13120
SEGURANÇA CONTRA RISCOS DE ESTRANGULAMENTO
MAIS INFORMAÇÕES NO NOSSO CATÁLOGO GERAL

SISTEMA DE ROLO MOSQUITEIRA

SISTEMA DE ROLO MOSQUITEIRA

MOSQUITEIRA DE MOLA

TABELA PREÇOS P.V.P €
iva não incluído

LARGURA

ALTURA

	0,6	0,7	0,8	0,9	1,0	1,1	1,2	1,3	1,4	1,5	1,6	1,7	1,8
0,6	74,34	81,90	88,44	94,34	101,90	108,10	114,56	122,90	129,34	135,90	142,26	149,80	155,20
0,7	76,42	83,28	89,24	97,60	103,40	110,04	118,90	124,88	131,64	137,08	145,88	152,70	158,64
0,8	79,72	85,34	92,66	99,72	106,86	112,22	120,80	126,86	133,30	140,78	147,74	153,38	161,90
0,9	82,68	88,80	94,10	101,26	109,92	116,80	122,90	129,30	135,92	142,52	149,06	156,66	163,90
1,0	84,98	91,70	97,40	104,56	110,62	110,80	124,96	131,36	138,90	144,22	151,08	158,64	165,40
1,1	86,90	92,90	99,20	107,98	113,74	120,56	127,82	132,08	140,30	148,90	153,20	161,40	167,66
1,2	89,90	95,88	102,68	109,90	115,60	121,02	129,26	136,52	142,80	149,20	156,60	163,88	170,12
1,3	90,02	97,98	104,90	110,24	118,98	125,80	131,54	138,38	144,40	152,88	159,38	164,12	172,90
1,4	93,86	98,90	106,22	114,90	119,22	127,52	133,52	140,02	147,28	154,84	160,10	168,38	174,80
1,5	95,70	102,34	108,46	116,68	123,46	129,28	136,90	142,74	149,48	156,12	163,82	170,90	176,34
1,6	96,06	104,12	112,80	118,68	125,90	131,90	138,20	145,40	152,80	158,34	165,62	172,80	179,10
1,7	107,48	115,30	124,90	132,16	141,98	149,80	157,48	165,24	174,98	181,58	188,34	196,08	205,84
1,8	111,80	118,04	126,16	134,90	142,20	150,46	159,72	167,96	175,22	184,82	191,08	200,32	208,58
1,9	112,60	121,90	129,92	137,42	145,06	153,80	161,78	169,74	178,98	186,92	193,30	202,30	210,84
2,0	115,80	123,74	131,90	139,28	148,90	156,88	164,75	172,56	180,90	188,74	196,98	204,18	212,00
2,1	117,80	124,04	132,16	142,90	149,20	157,46	165,72	174,96	182,22	191,82	198,08	206,32	214,58
2,2	120,60	128,90	136,92	143,42	152,80	160,78	168,74	176,98	185,92	192,30	201,30	209,84	217,80
2,3	122,80	129,04	138,16	147,90	154,20	163,46	170,72	179,96	186,22	195,82	203,08	211,32	219,58
2,4	124,60	132,90	141,92	148,42	157,80	165,78	173,74	182,98	190,92	197,30	205,30	214,84	222,80

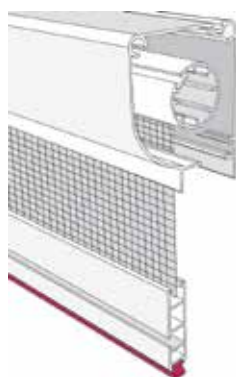

CAIXA DE ALUMINIO
COM GUIAS LATERAIS
 BRANCO

MOSQUITEIRA FIXA

PREÇOS P.V.P €
iva não incluído

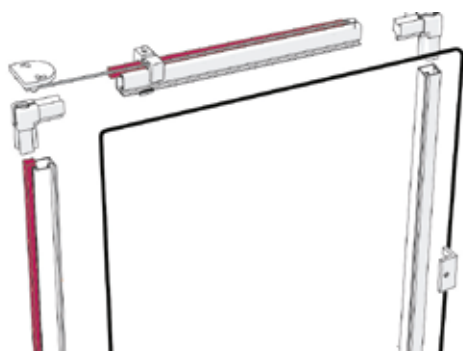

SISTEMA FIXO
PREÇO DO M2
69,98 €

SISTEMA DE BANDAS VERTICAIS

SISTEMA DE BANDAS VERTICAIS
127MM ou 89MM

COLEÇÕES:
IRÍS
SHANTUNG
LINHO

TABELA PREÇOS P.V.P €
iva não incluído

LARGURA

ALTURA	LARGURA												
	1,0	1,2	1,4	1,6	1,8	2,0	2,2	2,4	2,6	2,8	3,0	3,2	3,4
1,0	57,34	68,90	70,44	79,34	88,90	101,10	109,56	118,90	126,34	129,90	137,26	146,80	153,20
1,2	59,90	71,28	74,24	84,60	92,40	105,04	115,90	123,88	132,64	135,08	144,88	153,70	161,64
1,4	61,88	76,90	79,90	88,70	97,98	107,98	120,78	129,56	139,88	142,20	152,60	161,64	170,00
1,6	65,92	78,66	81,76	91,90	101,52	117,90	125,66	135,38	144,12	147,42	157,80	167,92	176,64
1,8	68,78	81,36	84,34	95,90	105,04	118,08	130,78	140,20	151,90	153,30	164,90	173,80	184,92
2,0	72,68	87,80	88,10	100,26	111,92	121,80	137,90	148,30	159,92	162,52	172,06	184,66	194,90
2,2	76,90	89,20	92,90	105,98	116,74	132,56	144,82	154,08	166,30	169,90	180,20	190,40	202,66
2,4	87,90	99,88	102,68	115,90	127,60	145,02	157,26	170,52	183,80	185,20	198,60	211,88	222,12
2,6	89,02	104,98	107,90	119,24	132,98	151,80	164,54	176,38	189,40	193,88	205,38	218,12	231,90
2,8	94,70	108,34	110,46	125,68	138,46	157,28	171,90	185,74	198,48	200,12	216,82	229,90	242,34
3,0	96,06	111,12	115,80	129,68	144,90	162,90	176,20	190,40	205,80	208,34	223,62	236,80	250,10
3,2	101,48	115,30	118,90	133,16	148,98	167,80	182,48	196,24	212,98	214,58	229,34	244,08	259,84
3,4	104,80	118,04	122,16	137,90	153,20	173,46	187,72	203,96	219,22	220,82	236,08	251,32	268,58
3,6	107,60	123,90	126,92	141,42	158,80	178,78	193,74	210,98	226,92	226,30	243,30	259,84	278,80
3,8	111,80	127,74	129,90	147,28	161,90	187,88	201,75	216,56	235,90	238,74	252,98	266,18	286,00
4,0	115,80	131,74	134,90	150,28	167,90	190,88	206,75	224,56	240,90	243,74	260,98	276,18	293,00

NOTA: Os estores são manuais com acionamento lateral de cordão e corrente branca.
Kits fornecidos com suportes de teto.

ALTURA	LARGURA		
	3,6	3,8	4,0
1,0	162,60	170,34	193,90
1,2	170,20	178,56	201,08
1,4	179,80	187,78	212,90
1,6	186,66	196,10	223,76
1,8	196,78	206,34	233,60
2,0	206,90	215,38	242,92
2,2	213,52	225,50	253,94
2,4	235,90	248,80	277,86
2,6	244,34	256,40	287,12
2,8	254,92	267,52	298,60
3,0	263,76	277,66	308,72
3,2	272,54	287,70	318,20
3,4	281,32	297,42	329,44
3,6	290,12	307,80	340,48
3,8	301,90	316,70	350,02
4,0	310,78	326,32	361,80



ESQUADRO 110MM
VALOR ACRESCIDO 2,28 €



ESQUADRO EXTENSIVEL
100MM-160MM
VALOR ACRESCIDO 5,88 €



SUPORTE TETO
SUPORTE STANDART
(COR STANDART: BRANCO)

ABERTURA ESQUERDA



ABERTURA DIREITA



ABERTURA CENTRAL



RECOLHA CENTRAL

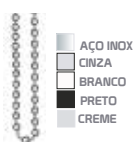

CORRENTE
(COR STANDART: BRANCO)

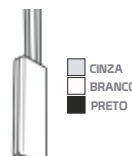

CONTRA-PESO CORDÃO
(COR STANDART: BRANCO)

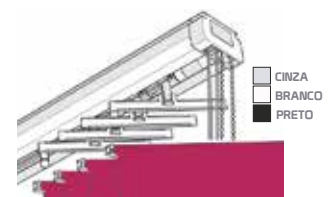

PERFIL + TERMINAIS
(COR STANDART: BRANCO)

SISTEMA DE BANDAS VERTICAIS
127MM ou 89MM

COLEÇÕES:
ALCOA
IRÍS BLACKOUT
SHANTUNG BLACKOUT

TABELA PREÇOS P.V.P €
iva não incluído

LARGURA

ALTURA	LARGURA												
	1,0	1,2	1,4	1,6	1,8	2,0	2,2	2,4	2,6	2,8	3,0	3,2	3,4
1,0	77,28	93,14	96,78	109,88	120,26	138,22	151,70	163,88	175,08	177,22	190,78	203,14	215,60
1,2	84,74	102,20	104,88	120,90	132,08	152,74	164,90	180,88	193,56	196,90	210,98	215,94	236,40
1,4	90,22	112,40	115,90	129,82	145,98	165,40	180,94	194,20	210,92	213,98	227,00	242,64	253,92
1,6	100,90	120,14	124,72	140,44	157,90	179,90	194,70	211,96	227,88	230,34	246,86	262,80	278,08
1,8	107,22	129,20	133,54	150,40	168,22	191,94	208,50	225,08	244,90	247,98	264,82	281,74	299,80
2,0	115,74	139,08	142,50	160,22	179,38	204,36	223,78	241,34	261,54	264,90	282,66	301,88	319,16
2,2	130,42	151,76	153,40	174,86	195,90	221,70	241,92	262,44	282,66	286,76	306,58	327,60	347,50
2,4	143,04	165,30	169,92	192,48	214,66	243,80	265,08	288,30	311,64	314,44	337,46	360,92	382,68
2,6	152,42	178,90	180,88	204,80	229,62	258,24	283,84	307,82	332,42	335,78	359,90	383,60	410,44
2,8	160,62	185,54	188,10	214,44	240,38	271,82	296,32	322,14	348,08	351,02	376,66	402,90	429,52
3,0	166,10	194,90	197,54	224,20	252,74	284,88	310,60	337,78	364,90	367,90	394,04	421,20	448,30
3,2	175,02	203,72	205,98	234,76	262,18	296,56	324,90	349,90	380,88	383,74	412,14	440,54	469,92
3,4	182,20	212,88	214,44	246,42	276,10	311,76	341,34	371,92	401,64	404,88	434,78	464,80	492,46
3,6	189,46	220,26	223,90	255,74	286,90	320,22	351,08	383,90	413,40	416,44	447,30	478,18	508,08
3,8	200,32	233,44	236,66	269,90	301,58	339,34	371,08	404,56	436,08	440,74	472,80	505,90	537,88
4,0	208,42	242,90	246,88	279,80	313,62	353,24	387,84	421,82	454,42	458,78	492,90	525,60	559,44

NOTA: Os estores são manuais com acionamento lateral de cordão e corrente branca.
Kits fornecidos com suportes de teto.

ALTURA	LARGURA			KIT				
	3,6	3,8	4,0	ESQUADRO 110MM	ESQUADRO EXTENSIVEL 100MM-160MM	SUPORTE TETO SUPORTE STANDART	ABERTURA	RECOLHA
1,0	227,60	239,34	268,90					
1,2	249,20	263,56	292,08					
1,4	272,80	287,78	318,90					
1,6	294,66	310,10	343,76					
1,8	316,32	333,22	368,90					
2,0	339,90	357,38	393,92					
2,2	361,52	381,50	418,94					
2,4	405,34	427,40	467,12					
2,6	429,90	452,12	493,40					
2,8	453,92	477,52	520,60					
3,0	475,76	502,66	546,72					
3,2	499,54	528,70	572,20					
3,4	522,32	552,42	599,44					
3,6	546,12	577,80	625,48					
3,8	570,90	602,70	652,02					
4,0	594,78	627,32	678,80					



ESQUADRO 110MM
VALOR ACRESCIDO 2,28 €



ESQUADRO EXTENSIVEL 100MM-160MM
VALOR ACRESCIDO 5,88 €



SUPORTE TETO SUPORTE STANDART (COR STANDART: BRANCO)



ABERTURA ESQUERDA



ABERTURA DIREITA



ABERTURA CENTRAL



RECOLHA CENTRAL



CORRENTE (COR STANDART: BRANCO)

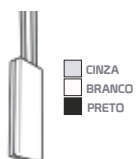

CONTRA-PESO CORDÃO (COR STANDART: BRANCO)



PERFIL + TERMINAIS (COR STANDART: BRANCO)

SISTEMA DE BANDAS VERTICAIS
127MM ou 89 MM

COLEÇÕES:
ESTEIRA
SCREEN 3500
LINHO BLACKOUT

TABELA PREÇOS P.V.P €
iva não incluído

LARGURA

ALTURA	LARGURA												
	1,0	1,2	1,4	1,6	1,8	2,0	2,2	2,4	2,6	2,8	3,0	3,2	3,4
1,0	77,28	93,14	96,78	109,88	120,26	138,22	151,70	163,88	175,08	177,22	190,78	203,14	215,60
1,2	84,74	102,20	104,88	120,90	132,08	152,74	164,90	180,88	193,56	196,90	210,98	215,94	236,40
1,4	90,22	112,40	115,90	129,82	145,98	165,40	180,94	194,20	210,92	213,98	227,00	242,64	253,92
1,6	100,90	120,14	124,72	140,44	157,90	179,90	194,70	211,96	227,88	230,34	246,86	262,80	278,08
1,8	107,22	129,20	133,54	150,40	168,22	191,94	208,50	225,08	244,90	247,98	264,82	281,74	299,80
2,0	115,74	139,08	142,50	160,22	179,38	204,36	223,78	241,34	261,54	264,90	282,66	301,88	319,16
2,2	130,42	151,76	153,40	174,86	195,90	221,70	241,92	262,44	282,66	286,76	306,58	327,60	347,50
2,4	143,04	165,30	169,92	192,48	214,66	243,80	265,08	288,30	311,64	314,44	337,46	360,92	382,68
2,6	152,42	178,90	180,88	204,80	229,62	258,24	283,84	307,82	332,42	335,78	359,90	383,60	410,44
2,8	160,62	185,54	188,10	214,44	240,38	271,82	296,32	322,14	348,08	351,02	376,66	402,90	429,52
3,0	166,10	194,90	197,54	224,20	252,74	284,88	310,60	337,78	364,90	367,90	394,04	421,20	448,30
3,2	175,02	203,72	205,98	234,76	262,18	296,56	324,90	349,90	380,88	383,74	412,14	440,54	469,92
3,4	182,20	212,88	214,44	246,42	276,10	311,76	341,34	371,92	401,64	404,88	434,78	464,80	492,46
3,6	189,46	220,26	223,90	255,74	286,90	320,22	351,08	383,90	413,40	416,44	447,30	478,18	508,08
3,8	200,32	233,44	236,66	269,90	301,58	339,34	371,08	404,56	436,08	440,74	472,80	505,90	537,88
4,0	208,42	242,90	246,88	279,80	313,62	353,24	387,84	421,82	454,42	458,78	492,90	525,60	559,44

NOTA: Os estores são manuais com acionamento lateral de cordão e corrente branca.
Kits fornecidos com suportes de teto.

ALTURA	3,6	3,8	4,0	ESQUADRO 110MM VALOR ACRESCIDO 2,28 €				ESQUADRO EXTENSIVEL 100MM-160MM VALOR ACRESCIDO 5,88 €		SUPORTE TETO SUPORTE STANDART (COR STANDART: BRANCO)	
	1,0	227,60	239,34	268,90				CINZA	BRANCO	PRETO	BRANCO
1,2	249,20	263,56	292,08								
1,4	272,80	287,78	318,90								
1,6	294,66	310,10	343,76								
1,8	316,32	333,22	368,90								
2,0	339,90	357,38	393,92								
2,2	361,52	381,50	418,94								
2,4	405,34	427,40	467,12								
2,6	429,90	452,12	493,40								
2,8	453,92	477,52	520,60								
3,0	475,76	502,66	546,72								
3,2	499,54	528,70	572,20								
3,4	522,32	552,42	599,44				BRANCO	PRETO	PRETO	PRETO	
3,6	546,12	577,80	625,48								
3,8	570,90	602,70	652,02								
4,0	594,78	627,32	678,80								

SISTEMA DE BANDAS VERTICAIS
127MM OU 89 MM

COLEÇÕES:
SCREEN TÊXTIL

TABELA PREÇOS P.V.P €
iva não incluído

LARGURA

ALTURA	LARGURA												
	1,0	1,2	1,4	1,6	1,8	2,0	2,2	2,4	2,6	2,8	3,0	3,2	3,4
1,0	77,28	93,14	96,78	109,88	120,26	138,22	151,70	163,88	175,08	177,22	190,78	203,14	215,60
1,2	84,74	102,20	104,88	120,90	132,08	152,74	164,90	180,88	193,56	196,90	210,98	215,94	236,40
1,4	90,22	112,40	115,90	129,82	145,98	165,40	180,94	194,20	210,92	213,98	227,00	242,64	253,92
1,6	100,90	120,14	124,72	140,44	157,90	179,90	194,70	211,96	227,88	230,34	246,86	262,80	278,08
1,8	107,22	129,20	133,54	150,40	168,22	191,94	208,50	225,08	244,90	247,98	264,82	281,74	299,80
2,0	115,74	139,08	142,50	160,22	179,38	204,36	223,78	241,34	261,54	264,90	282,66	301,88	319,16
2,2	130,42	151,76	153,40	174,86	195,90	221,70	241,92	262,44	282,66	286,76	306,58	327,60	347,50
2,4	143,04	165,30	169,92	192,48	214,66	243,80	265,08	288,30	311,64	314,44	337,46	360,92	382,68
2,6	152,42	178,90	180,88	204,80	229,62	258,24	283,84	307,82	332,42	335,78	359,90	383,60	410,44
2,8	160,62	185,54	188,10	214,44	240,38	271,82	296,32	322,14	348,08	351,02	376,66	402,90	429,52
3,0	166,10	194,90	197,54	224,20	252,74	284,88	310,60	337,78	364,90	367,90	394,04	421,20	448,30
3,2	175,02	203,72	205,98	234,76	262,18	296,56	324,90	349,90	380,88	383,74	412,14	440,54	469,92
3,4	182,20	212,88	214,44	246,42	276,10	311,76	341,34	371,92	401,64	404,88	434,78	464,80	492,46
3,6	189,46	220,26	223,90	255,74	286,90	320,22	351,08	383,90	413,40	416,44	447,30	478,18	508,08
3,8	200,32	233,44	236,66	269,90	301,58	339,34	371,08	404,56	436,08	440,74	472,80	505,90	537,88
4,0	208,42	242,90	246,88	279,80	313,62	353,24	387,84	421,82	454,42	458,78	492,90	525,60	559,44

NOTA: Os estores são manuais com acionamento lateral de cordão e corrente branca.
Kits fornecidos com suportes de teto.

ALTURA	LARGURA			ACESSÓRIOS			
	3,6	3,8	4,0	ESQUADRO 110MM	ESQUADRO EXTENSIVEL 100MM-160MM	SUPORTE TETO SUPORTE STANDART	ABERTURA
1,0	227,60	239,34	268,90	VALOR ACRESCIDO 2,22 €	VALOR ACRESCIDO 5,72 €	(COR STANDART: BRANCO)	ABERTURA ESQUERDA
1,2	249,20	263,56	292,08				ABERTURA DIREITA
1,4	272,80	287,78	318,90				ABERTURA CENTRAL
1,6	294,66	310,10	343,76				RECOLHA CENTRAL
1,8	316,32	333,22	368,90				
2,0	339,90	357,38	393,92				
2,2	361,52	381,50	418,94				
2,4	405,34	427,40	467,12				
2,6	429,90	452,12	493,40				
2,8	453,92	477,52	520,60				
3,0	475,76	502,66	546,72				
3,2	499,54	528,70	572,20				
3,4	522,32	552,42	599,44				
3,6	546,12	577,80	625,48				
3,8	570,90	602,70	652,02				
4,0	594,78	627,32	678,80				

CORRENTE
(COR STANDART: BRANCO)

CONTRA-PESO CORDÃO
(COR STANDART: BRANCO)

PERFIL + TERMINAIS
(COR STANDART: BRANCO)

SISTEMA DE BANDAS VERTICAIS
127MM OU 89 MM

COLEÇÕES:
SCREEN SOLAR
BLACKOUT SOLAR
SCREEN BLACKOUT

TABELA PREÇOS P.V.P €
iva não incluído

LARGURA

ALTURA

	1,0	1,2	1,4	1,6	1,8	2,0	2,2	2,4	2,6	2,8	3,0	3,2	3,4
1,0	210,28	256,14	262,78	298,88	333,26	378,22	413,70	449,88	484,08	490,22	525,78	560,14	596,60
1,2	233,74	285,20	290,88	330,90	369,08	419,74	459,90	498,88	538,56	543,90	584,98	623,94	663,40
1,4	256,22	314,40	318,90	363,02	406,98	460,40	504,94	548,20	592,92	598,98	641,00	685,64	729,92
1,6	282,90	345,14	350,72	399,44	448,90	506,90	555,70	603,96	651,88	658,34	706,86	754,80	802,08
1,8	307,22	376,20	382,54	435,40	489,22	552,94	605,50	658,08	710,90	717,98	770,82	824,74	876,80
2,0	332,74	407,08	413,50	471,22	529,38	597,10	656,12	712,20	770,26	776,70	834,88	892,90	949,54
2,2	358,22	439,90	444,82	507,34	570,82	642,98	705,50	768,90	832,48	839,90	903,66	968,88	1032,16
2,4	426,42	496,76	502,40	574,86	645,90	727,70	797,92	868,44	939,66	945,76	1016,58	1087,60	1157,50
2,6	454,22	530,66	535,28	612,10	688,68	774,98	850,34	925,90	1002,34	1008,32	1089,74	1159,90	1236,90
2,8	482,42	564,90	568,88	649,80	731,62	822,24	903,84	984,82	1065,42	1072,78	1152,90	1232,60	1313,44
3,0	510,62	596,54	601,10	688,44	774,38	870,82	956,32	1042,14	1127,08	1140,02	1220,66	1306,90	1391,52
3,2	538,10	629,90	634,54	726,20	816,74	918,88	1009,60	1100,78	1190,90	1196,90	1287,04	1378,20	1468,30
3,4	566,20	662,88	667,44	764,42	860,10	966,76	1061,34	1157,92	1253,64	1259,88	1355,78	1451,80	1547,46
3,6	595,20	689,88	694,44	802,42	903,10	1015,76	1115,34	1215,92	1316,64	1322,88	1423,78	1524,80	1624,46
3,8	623,46	728,26	734,90	840,74	946,90	1062,22	1168,08	1274,90	1379,40	1385,44	1491,30	1596,18	1702,08
4,0	653,32	763,44	767,66	878,90	988,58	1110,34	1221,08	1331,56	1442,08	1448,74	1559,80	1669,90	1779,88

NOTA: Os estores são manuais com acionamento lateral de cordão e corrente branca.
Kits fornecidos com suportes de teto.

ALTURA

	3,6	3,8	4,0
1,0	631,34	676,34	731,90
1,2	702,20	741,56	810,08
1,4	773,80	817,78	890,90
1,6	850,66	899,10	979,76
1,8	929,32	982,22	1067,90
2,0	1007,90	1065,38	1154,92
2,2	1086,52	1156,50	1243,94
2,4	1228,34	1299,40	1404,12
2,6	1312,90	1387,12	1496,40
2,8	1394,92	1474,52	1589,60
3,0	1477,76	1562,66	1681,72
3,2	1552,54	1650,70	1774,20
3,4	1642,32	1737,42	1874,44
3,6	1725,12	1826,80	1960,48
3,8	1807,90	1913,70	2052,02
4,0	1890,78	2001,32	2146,80



ESQUADRO 110MM
VALOR ACRESCIDO 2,22 €



ESQUADRO EXTENSIVEL
100MM-160MM
VALOR ACRESCIDO 5,72 €



SUPORTE TETO
SUPORTE STANDART
(COR STANDART: BRANCO)

ABERTURA ESQUERDA



ABERTURA DIREITA



ABERTURA CENTRAL



RECOLHA CENTRAL





CORRENTE
(COR STANDART: BRANCO)



CONTRA-PESO CORDÃO
(COR STANDART: BRANCO)



PERFIL + TERMINAIS
(COR STANDART: BRANCO)

SISTEMA DE BANDAS VERTICAIS
127MM OU 89 MM

COLEÇÕES:
SCREEN 1000

TABELA PREÇOS P.V.P €
iva não incluído

LARGURA

ALTEURA	LARGURA												
	1,0	1,2	1,4	1,6	1,8	2,0	2,2	2,4	2,6	2,8	3,0	3,2	3,4
1,0	93,34	113,90	116,44	131,34	146,90	168,10	182,56	196,90	212,34	215,90	230,26	246,80	260,20
1,2	101,20	123,28	126,24	145,60	161,40	184,04	199,90	217,88	233,64	236,08	253,88	259,70	286,64
1,4	112,08	135,90	139,90	157,70	175,98	199,98	218,28	235,56	254,88	257,20	276,60	293,64	312,00
1,6	120,92	146,66	150,76	169,90	189,52	216,90	235,66	255,38	275,12	278,42	297,80	317,92	336,64
1,8	129,78	157,36	160,34	182,90	203,04	231,08	253,78	273,20	295,90	298,30	320,90	341,80	362,92
2,0	139,68	168,80	172,10	195,02	218,26	247,92	269,80	293,90	316,30	319,92	342,52	365,06	388,66
2,2	147,90	183,20	186,20	212,98	236,74	267,56	292,82	318,08	342,30	346,90	371,20	396,40	421,66
2,4	176,90	200,88	204,68	232,90	260,60	294,02	322,26	349,52	376,80	381,20	408,60	435,88	470,12
2,6	185,12	214,98	217,90	248,24	277,98	313,80	342,54	372,38	402,40	405,88	435,38	465,12	494,90
2,8	193,86	225,10	228,22	259,90	291,22	328,52	359,52	391,02	422,28	425,84	457,10	488,38	519,80
3,0	201,70	235,34	238,46	272,68	304,46	345,28	376,90	409,74	441,48	447,12	477,82	510,90	543,34
3,2	212,34	246,56	251,80	286,68	320,90	361,90	395,20	430,40	464,80	468,34	502,62	536,80	571,10
3,4	222,06	259,30	262,90	299,16	335,98	378,80	414,48	450,24	486,98	490,58	526,34	562,08	598,84
3,6	232,80	270,04	273,16	313,90	350,20	394,46	432,72	465,96	507,22	511,82	550,08	587,32	625,58
3,8	243,60	282,90	286,92	325,42	365,80	412,78	451,74	490,98	529,92	533,30	572,30	612,84	651,80
4,0	253,80	294,74	297,90	339,28	380,90	429,88	472,75	509,56	551,90	555,74	596,98	637,18	678,00

NOTA: Os estores são manuais com acionamento lateral de cordão e corrente branca.
Kits fornecidos com suportes de teto.

ALTEURA	LARGURA		
	3,6	3,8	4,0
1,0	276,60	290,34	325,90
1,2	302,20	319,56	355,08
1,4	329,80	348,78	385,90
1,6	356,66	375,10	416,76
1,8	384,78	409,34	451,60
2,0	410,90	433,38	476,92
2,2	437,52	462,50	506,94
2,4	491,90	518,80	567,86
2,6	521,34	550,40	599,12
2,8	547,92	582,52	634,60
3,0	575,76	611,66	663,72
3,2	634,54	670,70	727,20
3,4	653,32	685,42	723,44
3,6	662,12	700,80	759,48
3,8	693,90	730,70	791,02
4,0	719,78	761,32	822,80



ESQUADRO 110MM
VALOR ACRESCIDO 2,22 €



ESQUADRO EXTENSIVEL
100MM-160MM
VALOR ACRESCIDO 5,72 €



SUPORTE TETO
SUPORTE STANDART
(COR STANDART: BRANCO)

ABERTURA ESQUERDA



ABERTURA DIREITA



ABERTURA CENTRAL



RECOLHA CENTRAL



CORRENTE
(COR STANDART: BRANCO)

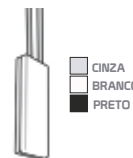

CONTRA-PESO CORDÃO
(COR STANDART: BRANCO)

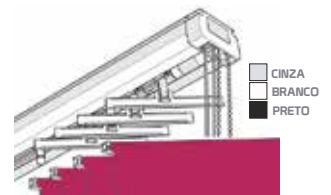

PERFIL + TERMINAIS
(COR STANDART: BRANCO)

SISTEMA DE BANDAS VERTICAIS
127MM OU 89 MM

COLEÇÕES:
JUTA
SCREEN DECOR

TABELA PREÇOS P.V.P €
Iva não incluído

LARGURA

ALTURA	LARGURA												
	1,0	1,2	1,4	1,6	1,8	2,0	2,2	2,4	2,6	2,8	3,0	3,2	3,4
1,0	210,28	256,14	262,78	298,88	333,26	378,22	413,70	449,88	484,08	490,22	525,78	560,14	596,60
1,2	233,74	285,20	290,88	330,90	369,08	419,74	459,90	498,88	538,56	543,90	584,98	623,94	663,40
1,4	256,22	314,40	318,90	363,02	406,98	460,40	504,94	548,20	592,92	598,98	641,00	685,64	729,92
1,6	282,90	345,14	350,72	399,44	448,90	506,90	555,70	603,96	651,88	658,34	706,86	754,80	802,08
1,8	307,22	376,20	382,54	435,40	489,22	552,94	605,50	658,08	710,90	717,98	770,82	824,74	876,80
2,0	332,74	407,08	413,50	471,22	529,38	597,10	656,12	712,20	770,26	776,70	834,88	892,90	949,54
2,2	358,22	439,90	444,82	507,34	570,82	642,98	705,50	768,90	832,48	839,90	903,66	968,88	1032,16
2,4	426,42	496,76	502,40	574,86	645,90	727,70	797,92	868,44	939,66	945,76	1016,58	1087,60	1157,50
2,6	454,22	530,66	535,28	612,10	688,68	774,98	850,34	925,90	1002,34	1008,32	1089,74	1159,90	1236,90
2,8	482,42	591,90	568,88	649,80	731,62	822,24	903,84	984,82	1065,42	1072,78	1152,90	1232,60	1313,44
3,0	510,62	596,54	601,10	688,44	774,38	870,82	956,32	1042,14	1127,08	1140,02	1220,66	1306,90	1391,52
3,2	538,10	629,90	634,54	726,20	816,74	918,88	1009,60	1100,78	1190,90	1196,90	1287,04	1378,20	1468,30
3,4	566,20	662,88	667,44	764,42	860,10	966,76	1061,34	1157,92	1253,64	1259,88	1355,78	1451,80	1547,46
3,6	595,20	689,88	694,44	802,42	903,10	1015,76	1115,34	1215,92	1316,64	1322,88	1423,78	1524,80	1624,46
3,8	623,46	728,26	734,90	840,74	946,90	1062,22	1168,08	1274,90	1379,40	1385,44	1491,30	1596,18	1702,08
4,0	653,32	763,44	767,66	878,90	988,58	1110,34	1221,08	1331,56	1442,08	1448,74	1559,80	1669,90	1779,88

NOTA: Os estores são manuais com acionamento lateral de cordão e corrente branca.
Kits fornecidos com suportes de teto.

ALTURA	3,6	3,8	4,0
	1,0	631,34	676,34
1,2	702,20	741,56	810,08
1,4	773,80	817,78	890,90
1,6	850,66	899,10	979,76
1,8	929,32	982,22	1067,90
2,0	1007,90	1065,38	1154,92
2,2	1086,52	1156,50	1243,94
2,4	1228,34	1299,40	1404,12
2,6	1312,90	1387,12	1496,40
2,8	1394,92	1474,52	1589,60
3,0	1477,76	1562,66	1681,72
3,2	1552,54	1650,70	1774,20
3,4	1642,32	1737,42	1874,44
3,6	1725,12	1826,80	1960,48
3,8	1807,90	1913,70	2052,02
4,0	1890,78	2001,32	2146,80



ESQUADRO 110MM
VALOR ACRESCIDO 2,22 €



ESQUADRO EXTENSIVEL
100MM-160MM
VALOR ACRESCIDO 5,72 €



SUPORTE TETO
SUPORTE STANDART
(COR STANDART: BRANCO)

ABERTURA ESQUERDA



ABERTURA DIREITA



ABERTURA CENTRAL



RECOLHA CENTRAL

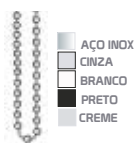

CORRENTE
(COR STANDART: BRANCO)

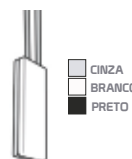

CONTRA-PESO CORDÃO
(COR STANDART: BRANCO)



PERFIL + TERMINAIS
(COR STANDART: BRANCO)

SISTEMA DE BANDAS VERTICAIS
127MM OU 89 MM

COLEÇÕES:
SCREEN 4500
SCREEN 5500

TABELA PREÇOS P.V.P €
iva não incluído

LARGURA

ALTURA	LARGURA												
	1,0	1,2	1,4	1,6	1,8	2,0	2,2	2,4	2,6	2,8	3,0	3,2	3,4
1,0	108,34	131,90	134,44	153,34	170,90	194,10	212,56	230,90	249,34	252,90	269,26	288,80	306,20
1,2	119,20	146,28	149,24	169,60	190,40	215,04	235,90	256,88	277,64	280,08	300,88	321,70	340,64
1,4	131,08	161,90	163,90	186,70	209,98	236,98	259,28	282,56	304,88	307,20	330,60	353,64	375,00
1,6	145,92	177,66	180,76	206,90	231,52	260,90	285,66	310,38	335,12	338,42	363,80	388,92	413,64
1,8	157,78	193,36	196,34	224,90	251,04	284,08	311,78	338,20	365,90	368,30	397,90	424,80	451,92
2,0	170,68	209,80	212,10	242,02	271,26	306,92	337,80	366,90	396,30	399,92	429,52	459,06	489,66
2,2	184,90	226,20	228,20	261,98	297,74	330,56	364,82	395,08	427,30	430,90	462,20	494,40	526,66
2,4	218,90	259,88	261,68	298,90	336,60	380,02	417,26	450,52	485,80	489,20	523,60	570,88	606,12
2,6	233,02	273,98	277,90	317,24	353,98	401,80	438,54	481,38	523,40	526,88	559,38	596,12	636,90
2,8	247,86	289,10	291,22	325,90	367,22	412,52	453,52	495,02	536,28	539,84	580,10	621,38	665,80
3,0	255,70	298,34	310,46	354,68	399,46	450,28	499,90	537,74	580,48	586,12	631,82	675,90	719,34
3,2	278,06	313,12	316,80	373,68	420,90	471,90	522,20	568,40	615,80	619,34	666,62	712,80	760,10
3,4	292,48	340,30	344,90	393,16	442,98	496,80	546,48	596,24	645,98	648,58	698,34	747,08	796,84
3,6	304,80	357,04	359,16	410,90	462,20	522,46	573,72	626,96	677,22	680,82	732,08	784,32	836,58
3,8	320,60	374,90	378,92	422,42	487,80	536,78	601,74	652,98	709,92	712,30	767,30	821,84	877,80
4,0	334,80	392,74	394,90	452,28	507,90	571,88	628,75	684,56	742,90	745,74	801,98	860,18	916,00

NOTA: Os estores são manuais com acionamento lateral de cordão e corrente branca.
Kits fornecidos com suportes de teto.

ALTURA	LARGURA		
	3,6	3,8	4,0
1,0	317,60	334,34	367,90
1,2	356,20	383,56	414,08
1,4	397,80	420,78	459,90
1,6	437,66	462,10	504,76
1,8	477,78	505,34	548,60
2,0	519,90	547,38	594,92
2,2	564,52	591,50	639,94
2,4	632,90	669,80	723,86
2,6	675,34	714,40	770,12
2,8	717,92	761,52	817,60
3,0	768,76	813,66	869,72
3,2	807,54	854,70	917,20
3,4	845,32	895,42	965,44
3,6	887,12	940,80	1009,48
3,8	931,90	984,70	1056,02
4,0	973,78	1030,32	1104,80



ESQUADRO 110MM
VALOR ACRESCIDO 2,22 €



ESQUADRO EXTENSIVEL
100MM-160MM
VALOR ACRESCIDO 5,72 €



SUPORTE TETO
SUPORTE STANDART
(COR STANDART: BRANCO)

ABERTURA ESQUERDA



ABERTURA DIREITA



ABERTURA CENTRAL



RECOLHA CENTRAL



CORRENTE
(COR STANDART: BRANCO)

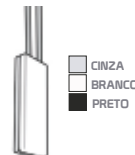

CONTRA-PESO CORDÃO
(COR STANDART: BRANCO)

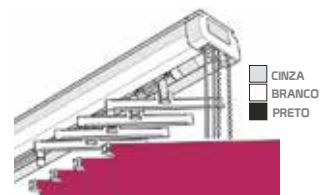

PERFIL + TERMINAIS
(COR STANDART: BRANCO)

SISTEMA DE BANDAS VERTICAIS
127MM OU 89 MM

COLEÇÕES:
SCREEN FANTASIA

TABELA PREÇOS P.V.P €
iva não incluído

LARGURA

ALTURA	LARGURA												
	1,0	1,2	1,4	1,6	1,8	2,0	2,2	2,4	2,6	2,8	3,0	3,2	3,4
1,0	108,34	131,90	134,44	153,34	170,90	194,10	212,56	230,90	249,34	252,90	269,26	288,80	306,20
1,2	119,20	146,28	149,24	169,60	190,40	215,04	235,90	256,88	277,64	280,08	300,88	321,70	340,64
1,4	131,08	161,90	163,90	186,70	209,98	236,98	259,28	282,56	304,88	307,20	330,60	353,64	375,00
1,6	145,92	177,66	180,76	206,90	231,52	260,90	285,66	310,38	335,12	338,42	363,80	388,92	413,64
1,8	157,78	193,36	196,34	224,90	251,04	284,08	311,78	338,20	365,90	368,30	397,90	424,80	451,92
2,0	170,68	209,80	212,10	242,02	271,26	306,92	337,80	366,90	396,30	399,92	429,52	459,06	489,66
2,2	184,90	226,20	228,20	261,98	297,74	330,56	364,82	395,08	427,30	430,90	462,20	494,40	526,66
2,4	218,90	259,88	261,68	298,90	336,60	380,02	417,26	450,52	485,80	489,20	523,60	570,88	606,12
2,6	233,02	273,98	277,90	317,24	353,98	401,80	438,54	481,38	523,40	526,88	559,38	596,12	636,90
2,8	247,86	289,10	291,22	325,90	367,22	412,52	453,52	495,02	536,28	539,84	580,10	621,38	665,80
3,0	255,70	298,34	310,46	354,68	399,46	450,28	499,90	537,74	580,48	586,12	631,82	675,90	719,34
3,2	278,06	313,12	316,80	373,68	420,90	471,90	522,20	568,40	615,80	619,34	666,62	712,80	760,10
3,4	292,48	340,30	344,90	393,16	442,98	496,80	546,48	596,24	645,98	648,58	698,34	747,08	796,84
3,6	304,80	357,04	359,16	410,90	462,20	522,46	573,72	626,96	677,22	680,82	732,08	784,32	836,58
3,8	320,60	374,90	378,92	422,42	487,80	536,78	601,74	652,98	709,92	712,30	767,30	821,84	877,80
4,0	334,80	392,74	394,90	452,28	507,90	571,88	628,75	684,56	742,90	745,74	801,98	860,18	916,00

NOTA: Os estores são manuais com acionamento lateral de cordão e corrente branca.
Kits fornecidos com suportes de teto.

ALTURA	3,6	3,8	4,0
	1,0	317,60	334,34
1,2	356,20	383,56	414,08
1,4	397,80	420,78	459,90
1,6	437,66	462,10	504,76
1,8	477,78	505,34	548,60
2,0	519,90	547,38	594,92
2,2	564,52	591,50	639,94
2,4	632,90	669,80	723,86
2,6	675,34	714,40	770,12
2,8	717,92	761,52	817,60
3,0	768,76	813,66	869,72
3,2	807,54	854,70	917,20
3,4	845,32	895,42	965,44
3,6	887,12	940,80	1009,48
3,8	931,90	984,70	1056,02
4,0	973,78	1030,32	1104,80



ESQUADRO 110MM
VALOR ACRESCIDO 2,22 €



ESQUADRO EXTENSIVEL
100MM-160MM
VALOR ACRESCIDO 5,72 €



SUPORTE TETO
SUPORTE STANDART
(COR STANDART: BRANCO)

ABERTURA ESQUERDA



ABERTURA DIREITA



ABERTURA CENTRAL



RECOLHA CENTRAL

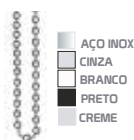

CORRENTE
(COR STANDART: BRANCO)

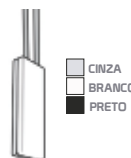

CONTRA-PESO CORDÃO
(COR STANDART: BRANCO)



PERFIL + TERMINAIS
(COR STANDART: BRANCO)



SISTEMA DE PAINEL DESLIZANTE

TELAS PARA PAINEL DESLIZANTE

Características técnicas

TABELA PREÇOS P.V.P €
iva não incluído

CHIC



LARGURA

	0,8	1,0	1,2	1,4	1,6
1,0	37,82	40,06	44,22	48,48	52,82
1,2	39,30	43,60	47,08	52,46	56,48
1,4	41,14	46,32	51,74	55,22	61,02
1,6	43,14	49,32	54,74	59,22	64,02
1,8	46,98	51,04	57,22	63,88	65,94
2,0	48,84	54,78	60,02	67,30	73,08
2,2	50,08	57,32	64,44	72,00	77,54
2,4	52,36	60,28	67,68	74,44	82,90
2,6	55,88	62,88	70,12	78,70	86,14
2,8	58,30	65,04	74,02	82,48	90,50
3,0	60,98	68,26	77,40	86,06	94,04

IRÍS



LARGURA

	0,8	1,0	1,2	1,4	1,6
1,0	27,82	29,96	33,22	35,48	37,82
1,2	29,30	32,60	35,08	38,46	41,48
1,4	30,14	34,32	37,74	41,22	44,02
1,6	32,14	36,32	40,74	43,22	47,42
1,8	34,98	38,04	42,22	46,88	51,94
2,0	35,84	40,78	44,02	49,30	54,08
2,2	37,08	42,32	47,44	52,50	57,54
2,4	39,36	44,28	49,68	54,44	60,90
2,6	40,88	46,88	52,12	57,70	63,14
2,8	42,30	48,04	54,02	60,48	66,50
3,0	43,98	50,26	56,40	63,06	70,00

IRIS BLACKOUT



LARGURA

	0,8	1,0	1,2	1,4	1,6
1,0	43,82	49,06	55,22	61,48	66,82
1,2	47,30	54,60	61,08	67,46	74,48
1,4	51,14	57,32	65,74	74,22	81,02
1,6	55,14	63,32	71,74	80,22	88,02
1,8	58,98	67,04	76,22	86,88	95,94
2,0	61,84	72,72	82,02	92,30	102,08
2,2	65,08	76,32	87,44	98,00	110,54
2,4	69,36	80,28	92,68	104,44	115,90
2,6	73,88	85,88	97,12	110,70	122,14
2,8	76,30	89,04	102,02	116,48	129,50
3,0	80,98	94,26	108,40	122,06	136,00

ALCOA



LARGURA

	0,8	1,0	1,2	1,4	1,6
1,0	40,82	46,06	51,22	56,48	61,82
1,2	43,30	49,60	55,08	61,46	67,48
1,4	47,14	54,32	60,74	66,22	73,02
1,6	50,14	56,32	64,74	71,22	79,02
1,8	53,98	61,04	69,22	77,88	86,94
2,0	56,84	66,78	73,02	82,30	91,08
2,2	59,08	68,32	78,44	87,00	96,54
2,4	62,36	72,28	82,68	92,44	102,90
2,6	66,88	76,88	87,12	98,70	108,14
2,8	68,30	80,04	92,02	103,48	114,50
3,0	71,98	84,26	96,40	108,06	120,00

NOTA: Os preços acima são unicamente das telas, valor ao qual o cliente terá que somar o preço do kit.
Preços dos kits, Painel japonês e Painel japonês Decorativo poderão ser consultados no nosso catálogo geral.



CONTRA-PESO
INTERIOR
(STANDART)

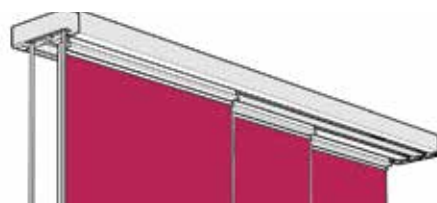

TELAS PARA PAINEL DESLIZANTE

Características técnicas

TABELA PREÇOS P.V.P €
iva não incluído

SCREEN BLACKOUT



LARGURA

		0,8	1,0	1,2	1,4	1,6
ALTURA	1,0	96,82	114,06	131,22	149,48	167,82
	1,2	107,30	126,60	147,08	167,46	187,48
	1,4	117,14	140,32	162,74	185,22	208,02
	1,6	128,14	153,32	178,74	202,22	227,02
	1,8	139,98	165,04	193,22	220,88	248,94
	2,0	149,84	179,78	209,02	238,30	267,08
	2,2	160,08	192,32	224,44	256,00	288,54
	2,4	166,36	204,28	239,68	273,44	307,90
	2,6	181,88	218,88	255,12	291,70	329,14
	2,8	192,30	231,04	270,02	309,48	348,50
3,0	202,98	244,26	285,40	327,06	369,00	

SCREEN 1000



LARGURA

		0,8	1,0	1,2	1,4	1,6
ALTURA	1,0	56,82	64,06	73,22	82,48	90,82
	1,2	62,30	71,60	80,08	90,46	99,48
	1,4	67,14	77,32	88,74	98,22	109,02
	1,6	73,14	84,32	96,74	107,22	119,02
	1,8	77,98	89,04	103,22	115,88	128,94
	2,0	83,84	95,78	110,02	124,30	138,08
	2,2	87,08	102,32	117,44	132,00	148,54
	2,4	91,36	108,28	124,68	141,44	157,90
	2,6	97,88	114,88	131,12	149,70	166,14
	2,8	101,30	120,04	139,02	157,48	176,50
3,0	107,98	126,26	146,40	166,06	186,40	

SCREEN 3500



LARGURA

		0,8	1,0	1,2	1,4	1,6
ALTURA	1,0	42,82	48,06	54,22	59,48	64,82
	1,2	46,30	52,60	58,08	64,46	71,48
	1,4	49,14	55,32	63,74	70,22	77,02
	1,6	53,14	60,32	68,74	76,22	83,02
	1,8	56,98	64,04	73,22	82,88	90,94
	2,0	59,84	69,78	79,02	88,30	96,08
	2,2	63,08	73,32	83,44	93,00	103,54
	2,4	66,36	76,28	87,68	98,44	109,90
	2,6	68,88	81,88	93,12	104,70	117,14
	2,8	73,30	85,04	97,02	110,48	122,50
3,0	76,98	89,26	104,40	116,06	129,40	

SCREEN 4500



LARGURA

		0,8	1,0	1,2	1,4	1,6
ALTURA	1,0	53,82	60,06	67,22	75,48	83,82
	1,2	58,30	66,60	75,08	83,46	94,48
	1,4	63,14	72,32	80,74	91,22	102,02
	1,6	67,14	77,32	89,74	99,22	109,02
	1,8	71,98	83,04	95,22	106,88	118,94
	2,0	75,84	88,78	101,02	115,30	126,08
	2,2	79,08	94,32	107,44	121,00	135,54
	2,4	84,36	100,28	113,68	129,44	144,90
	2,6	88,88	104,88	121,12	136,70	153,14
	2,8	93,30	110,04	127,02	145,48	162,50
3,0	98,98	116,26	132,40	153,06	170,20	

NOTA: Os preços acima são unicamente das telas, valor ao qual o cliente terá que somar o preço do kit.
Preços dos kits, Painel japonês e Painel japonês Decorativo poderão ser consultados no nosso catálogo geral.



CONTRA-PESO
INTERIOR
(STANDART)

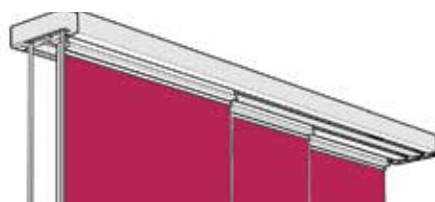

TELAS PARA PAINEL DESLIZANTE

Características técnicas

TABELA PREÇOS P.V.P €

iva não incluído

SCREEN 5500

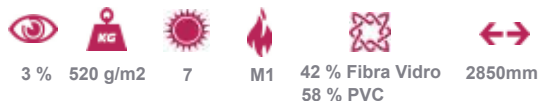

LARGURA

	0,8	1,0	1,2	1,4	1,6
1,0	63,82	73,06	83,22	93,48	103,82
1,2	68,30	80,60	92,08	103,46	114,48
1,4	74,14	87,32	99,74	113,22	125,02
1,6	80,14	94,32	109,74	123,22	138,02
1,8	86,98	101,04	118,22	133,88	149,94
2,0	92,84	110,78	126,02	144,30	160,08
2,2	98,08	117,32	135,44	153,00	172,54
2,4	105,36	124,28	144,68	163,44	183,90
2,6	111,88	131,88	153,12	174,70	195,14
2,8	117,30	140,04	161,02	184,48	207,50
3,0	123,98	147,26	170,40	194,06	218,00

JUTA



LARGURA

	0,8	1,0	1,2	1,4	1,6
1,0	73,82	87,06	100,22	111,48	124,82
1,2	82,30	96,60	110,08	124,46	137,48
1,4	89,14	105,32	119,74	135,22	151,02
1,6	97,14	115,32	132,74	149,22	166,02
1,8	105,98	124,04	143,22	161,88	180,94
2,0	112,84	133,78	153,02	174,30	194,08
2,2	120,08	142,32	164,44	185,00	208,54
2,4	127,36	151,28	175,68	198,44	222,90
2,6	134,88	160,88	185,12	211,70	236,14
2,8	142,30	169,04	196,02	223,48	250,50
3,0	149,98	178,26	207,40	235,06	264,78

SCREEN DECOR

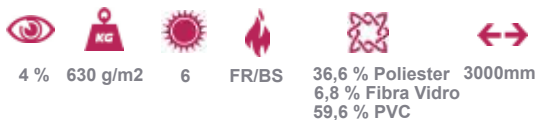

LARGURA

	0,8	1,0	1,2	1,4	1,6
1,0	98,82	116,06	133,22	151,48	168,82
1,2	109,30	128,60	149,08	168,46	188,48
1,4	119,14	142,32	164,74	186,22	209,02
1,6	130,14	154,32	179,74	203,22	228,02
1,8	141,98	167,04	194,22	221,88	248,94
2,0	151,84	181,78	210,02	238,30	268,08
2,2	161,08	193,32	225,44	256,00	288,54
2,4	173,36	207,28	241,68	275,44	307,90
2,6	183,88	219,88	255,12	292,70	328,14
2,8	193,30	232,04	270,02	310,48	348,50
3,0	203,98	245,26	286,40	327,06	368,70

ESTEIRA



LARGURA

	0,8	1,0	1,2	1,4	1,6
1,0	40,82	43,06	48,22	52,48	56,82
1,2	42,30	47,60	51,08	56,46	61,48
1,4	45,14	50,32	55,74	60,22	65,02
1,6	47,14	53,32	59,74	64,22	70,02
1,8	50,98	56,04	62,22	68,88	75,94
2,0	52,84	59,78	66,02	73,30	79,08
2,2	54,08	62,32	69,44	77,00	84,54
2,4	57,36	65,28	73,68	81,44	89,90
2,6	59,88	68,88	76,12	85,70	94,14
2,8	62,30	71,04	80,02	89,48	98,50
3,0	64,98	74,26	84,40	94,06	103,00

NOTA: Os preços acima são unicamente das telas, valor ao qual o cliente terá que somar o preço do kit.
Preços dos kits, Painel japonês e Painel japonês Decorativo poderão ser consultados no nosso catálogo geral.



CONTRA-PESO
INTERIOR
(STANDART)

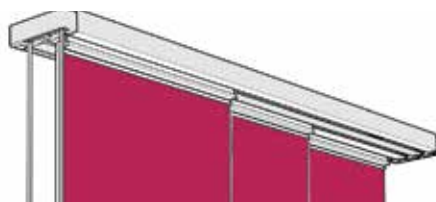

TELAS PARA PAINEL DESLIZANTE

Características técnicas

TABELA PREÇOS P.V.P €
iva não incluído

SCREEN SOLAR



LARGURA

		LARGURA				
		0,8	1,0	1,2	1,4	1,6
ALTURA	1,0	93,82	109,06	126,22	143,48	160,82
	1,2	104,30	122,60	141,08	160,46	177,48
	1,4	114,14	134,32	155,74	176,22	197,02
	1,6	123,14	146,32	169,74	192,22	216,02
	1,8	133,98	158,04	184,22	209,88	234,94
	2,0	143,84	170,78	198,02	225,30	252,08
	2,2	153,08	182,32	212,44	241,00	271,54
	2,4	163,36	194,28	226,68	258,44	289,90
	2,6	173,88	206,88	240,12	274,70	308,14
	2,8	182,30	219,04	255,02	291,48	327,50
3,0	192,98	231,26	269,40	307,06	345,06	

BLACKOUT SOLAR



LARGURA

		LARGURA				
		0,8	1,0	1,2	1,4	1,6
ALTURA	1,0	93,82	109,06	126,22	143,48	160,82
	1,2	104,30	122,60	141,08	160,46	177,48
	1,4	114,14	134,32	155,74	176,22	197,02
	1,6	123,14	146,32	169,74	192,22	216,02
	1,8	133,98	158,04	184,22	209,88	234,94
	2,0	143,84	170,78	198,02	225,30	252,08
	2,2	153,08	182,32	212,44	241,00	271,54
	2,4	163,36	194,28	226,68	258,44	289,90
	2,6	173,88	206,88	240,12	274,70	308,14
	2,8	182,30	219,04	255,02	291,48	327,50
3,0	192,98	231,26	269,40	307,06	345,06	

SHANTUNG BLACKOUT



LARGURA

		LARGURA				
		0,8	1,0	1,2	1,4	1,6
ALTURA	1,0	45,82	50,06	55,22	60,48	66,82
	1,2	48,30	54,60	60,08	66,46	71,48
	1,4	51,14	58,32	64,74	71,22	77,02
	1,6	54,14	62,32	69,74	76,22	83,02
	1,8	57,98	65,04	73,22	81,88	89,94
	2,0	60,84	69,78	77,02	86,30	94,08
	2,2	63,08	73,32	82,44	91,00	100,54
	2,4	67,36	76,28	86,68	96,44	106,90
	2,6	70,88	80,88	91,12	101,70	113,14
	2,8	76,30	84,04	95,02	106,48	119,50
3,0	77,98	89,26	100,40	112,06	122,00	

LINHO BLACKOUT



LARGURA

		LARGURA				
		0,8	1,0	1,2	1,4	1,6
ALTURA	1,0	41,82	46,06	51,22	54,48	60,82
	1,2	45,30	50,60	55,08	60,46	65,48
	1,4	47,14	53,32	58,74	64,22	70,02
	1,6	50,14	56,32	62,74	68,22	75,02
	1,8	53,98	59,04	66,22	73,88	80,94
	2,0	55,84	63,78	70,02	77,30	85,08
	2,2	58,08	66,32	74,44	82,00	90,54
	2,4	61,36	69,28	78,68	86,44	95,90
	2,6	63,88	72,88	80,12	91,70	100,14
	2,8	66,30	76,04	85,02	95,48	105,50
3,0	68,98	79,26	89,40	99,06	110,00	

NOTA: Os preços acima são unicamente das telas, valor ao qual o cliente terá que somar o preço do kit.
Preços dos kits, Painel japonês e Painel japonês Decorativo poderão ser consultados no nosso catálogo geral.



CONTRA-PESO
INTERIOR
(STANDART)

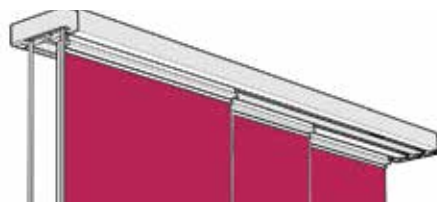

TELAS PARA PAINEL DESLIZANTE

Características técnicas

TABELA PREÇOS P.V.P €
iva não incluido

LINHO



LARGURA

	0,8	1,0	1,2	1,4	1,6
1,0	28,82	30,06	33,22	36,48	38,82
1,2	30,30	33,60	35,08	38,46	41,48
1,4	31,12	34,38	37,76	40,28	43,06
1,6	33,14	36,32	39,74	43,22	45,02
1,8	34,98	38,04	41,22	45,88	49,94
2,0	36,84	40,78	43,02	47,30	51,08
2,2	37,08	41,32	45,44	50,00	54,54
2,4	38,36	43,28	47,68	52,44	57,90
2,6	40,88	45,88	50,12	54,20	59,14
2,8	41,30	46,04	52,02	57,48	62,50
3,0	43,98	48,26	54,40	59,06	65,00

MICRO SHANTUNG



LARGURA

	0,8	1,0	1,2	1,4	1,6
1,0	34,82	37,06	41,22	44,48	47,82
1,2	36,30	40,60	43,08	47,46	51,48
1,4	38,18	42,34	46,72	50,20	54,08
1,6	40,14	44,32	49,74	54,22	58,02
1,8	42,98	47,04	52,22	57,88	62,94
2,0	44,84	49,78	55,02	60,30	65,08
2,2	46,08	52,32	57,44	63,00	69,54
2,4	48,36	54,28	60,68	66,44	73,90
2,6	50,88	57,88	64,12	70,70	76,14
2,8	52,30	60,04	66,02	73,48	80,50
3,0	54,98	62,26	69,40	76,06	85,00

SHANTUNG



LARGURA

	0,8	1,0	1,2	1,4	1,6
1,0	29,82	31,06	34,22	36,48	40,82
1,2	30,30	33,60	36,08	39,46	42,48
1,4	32,16	35,38	38,70	42,24	45,08
1,6	33,14	37,32	41,74	44,22	48,02
1,8	35,98	39,04	43,22	47,88	51,94
2,0	36,84	41,78	45,02	49,30	54,08
2,2	38,08	43,32	47,44	53,00	57,54
2,4	40,36	45,28	50,68	55,44	60,90
2,6	41,88	46,88	52,12	57,70	63,14
2,8	43,30	48,04	54,02	60,48	66,50
3,0	44,98	50,26	56,40	63,06	69,00

SCREEN TÊXTIL



LARGURA

	0,8	1,0	1,2	1,4	1,6
1,0	42,82	48,06	54,22	59,48	64,82
1,2	46,30	52,60	58,08	64,46	71,48
1,4	49,16	55,38	63,76	70,20	77,00
1,6	53,14	60,32	68,74	76,22	83,02
1,8	56,98	64,04	73,22	82,88	90,94
2,0	59,84	69,78	79,02	88,30	96,08
2,2	63,08	73,32	83,44	93,00	103,54
2,4	66,36	76,28	87,68	98,44	109,90
2,6	68,88	81,88	93,12	104,70	117,14
2,8	73,30	85,04	97,02	110,48	122,50
3,0	76,98	89,26	104,40	116,06	129,40

NOTA: Os preços acima são unicamente das telas, valor ao qual o cliente terá que somar o preço do kit.
Preços dos kits, Painel japonês e Painel japonês Decorativo poderão ser consultados no nosso catálogo geral.



CONTRA-PESO
INTERIOR
(STANDART)

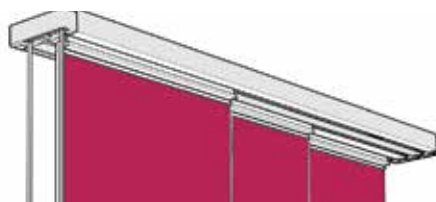

SISTEMA VENEZIANO DE MADEIRA

SISTEMA VENEZIANO DE MADEIRA 50MM

TABELA PREÇOS P.V.P €
iva não incluído

ACABAMENTO COM CINTA DE ESCADA

		LARGURA							
		1,0	1,2	1,4	1,6	1,8	2,0	2,2	2,4
ALTURA	1,0	161,28	194,14	225,78	257,88	285,26	322,22	354,70	386,88
	1,2	193,74	231,20	270,88	309,90	347,08	386,74	425,90	463,88
	1,4	225,22	270,40	315,90	360,02	405,98	450,40	495,94	540,20
	1,6	256,90	309,14	360,72	412,44	463,90	515,90	566,70	618,96
	1,8	283,22	347,20	405,54	463,40	521,22	573,94	637,50	659,08
	2,0	324,74	386,08	451,50	516,22	572,38	644,10	708,12	772,20
	2,2	355,22	426,90	496,82	567,34	638,82	709,98	779,50	850,90
	2,4	387,42	464,76	541,40	619,86	660,90	773,70	851,92	
	2,6	413,22	502,66	588,28	669,10	753,68	837,98		
	2,8	450,42	540,90	631,88	721,80	811,62			
3,0	483,62	579,54	676,10	772,44	869,38				

ACABAMENTO COM CORDÃO DE ESCADA

		LARGURA							
		1,0	1,2	1,4	1,6	1,8	2,0	2,2	2,4
ALTURA	1,0	155,28	186,14	217,78	248,88	279,26	310,22	341,70	372,20
	1,2	187,74	223,20	260,88	297,90	334,08	372,74	409,90	446,88
	1,4	218,22	260,40	303,90	347,02	390,98	434,40	477,94	520,20
	1,6	249,90	297,14	347,72	396,44	446,90	496,90	545,70	595,96
	1,8	280,22	334,20	390,54	446,40	502,22	558,94	613,50	669,08
	2,0	311,74	372,08	434,50	496,22	559,38	620,10	682,12	744,20
	2,2	342,22	409,90	477,82	545,34	613,82	682,98	750,50	818,90
	2,4	373,42	446,76	520,40	595,86	669,90	744,70	818,92	
	2,6	403,22	483,66	564,28	644,10	725,68	806,98		
	2,8	434,42	520,90	607,88	694,80	781,62			
3,0	465,62	558,54	651,10	744,44	837,38				

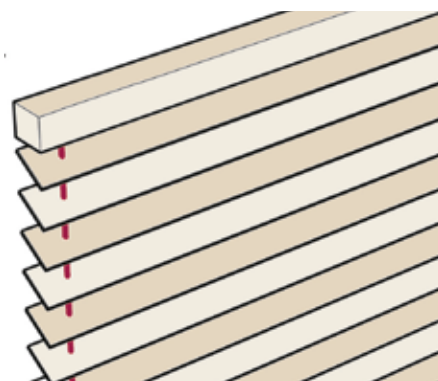

FOLHAS DE PEDIDOS

CÓDIGO CLIENTE: _____

CLIENTE: _____

MORADA ENTREGA: _____

DATA: ___ / ___ / ___

PEDIDO ESTORES DE ROLO

QTD.	REFÊRENCIA / COLEÇÃO	LARGURA	ALTURA	COMANDO	
				ESQ	DRT

ASSINALE COM "X" AS OPÇÕES ABAIXO



AÇO INOX
 CINZA
 BRANCO
 PRETO
 CREME

CORRENTE
(COR STANDART: BRANCO)



JANELA

ENROLAMENTO EXTERIOR (STANDART)



JANELA

ENROLAMENTO INTERIOR



SISTEMA DESMULTIPLICADOR



CINZA
 BRANCO
 PRETO
 CREME

TAMPAS E SUPORTES
(COR STANDART: BRANCO)



CONTRA-PESO DECORATIVO



CONTRA-PESO INTERIOR (STANDART)



SUPORTE CAIXA 80



SUPORTE CAIXA 90



CINZA
 BRANCO
 PRETO
 CREME

GUIAS LATERAIS 60X27



CAIXA 80MM



CAIXA 90MM

CINZA
 BRANCO
 PRETO
 CREME



KIT MANIVELA AMOVIVEL



MOTOR COM RECETOR PARA COMANDO



TELECOMANDO 1 CANAL

TELECOMANDO 4 CANAIS

TELECOMANDO 6 CANAIS

TELECOMANDO 8 CANAIS



MOTOR PARA LIGAÇÃO 220V



INTERRUPTOR PAREDE 1 CANAL

INTERRUPTOR PAREDE 2 CANAIS

**PEDIDO PAINEL
DESLIZANTE**

CÓDIGO CLIENTE: _____

CLIENTE: _____

MORADA ENTREGA: _____

DATA: ____ / ____ / ____

QTD. TELAS	REFÊRENCIA / COLEÇÃO	LARGURA	ALTURA

NOTA: A FOLHA DE PEDIDO É DE SOMENTE DE TELAS, LARGURAS DE TELAS ACABADAS.

